

# SCOPE



## A STEP INTO THE UNKNOWN

*AI in medical physics  
and engineering*

### RADIOTHERAPY

Auto contouring  
for prostate and  
pelvic radiotherapy

### AFTER BREXIT

What does the UK-EU  
deal mean for scientific  
research and funding?

### CYBERNETICS

Prosthetics and  
phantom motion intent  
from bio-signals

### TRAILBLAZERS

A look back at the  
women physicists of  
the Royal Free Hospital

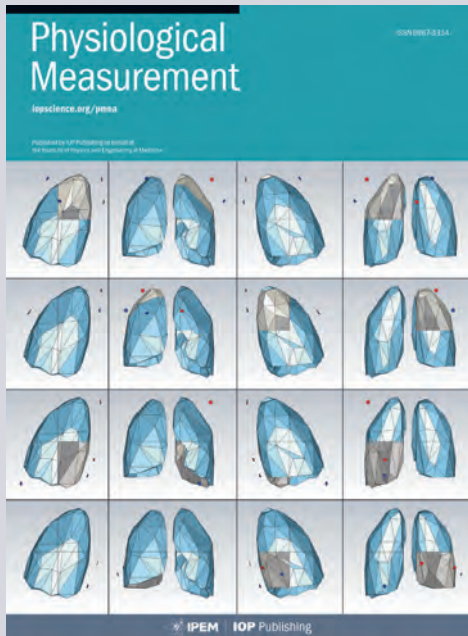

# Physiological Measurement

JOURNAL  
IMPACT FACTOR  
**2.309**

[iopscience.org/pmea](http://iopscience.org/pmea)

*Physiological Measurement* (PMEA) covers the quantitative assessment and visualization of physiological function in clinical research and practice, with an emphasis on the development of new methods of measurement and their validation.

**Editor-in-Chief**

**Xiao Hu**

Duke University, USA



To find out more about submitting, visit  
[iopscience.org/pmea](http://iopscience.org/pmea) or e-mail  
[pmea@iopublishing.org](mailto:pmea@iopublishing.org).

 **IPEM** | **IOP Publishing**



# Physics in Medicine & Biology

JOURNAL  
IMPACT FACTOR  
**2.883**

[iopscience.org/pmb](http://iopscience.org/pmb)

*Physics in Medicine & Biology* (PMB) covers the development and application of theoretical, computational and experimental physics to medicine, physiology and biology.

**Editor-in-Chief**

**Katia Parodi**

Ludwig-Maximilians University, Germany



To find out more about submitting, visit  
[iopscience.org/pmb](http://iopscience.org/pmb) or e-mail  
[pmb@iopublishing.org](mailto:pmb@iopublishing.org).

 **IPEM** | **IOP Publishing**

CHAIR OF IPEM SCOPE EDITORIAL ADVISORY BOARD

# Making great strides

Usman Lula outlines the content in the latest issue of *Scope* and welcomes two new commissioning editors.



White Paper on health and social care and its implications for IPEM members and professions. We also have some really exciting content around the AI theme that covers several areas under IPEM, including radiotherapy, radiology, nuclear medicine, molecular imaging and clinical and biomedical engineering.

Paul Barrett, IPEM's Senior Communications Manager, and I have

been discussing ways to improve engagement with the readership – an area where he has lots of expertise. Engagement forms part of the third strategic item of *Scope* and thus Paul will be instrumental in supporting us to meet our goals. We will certainly be using the results from the recent *Scope* survey (2021) to guide us along the way as well as input from IPEM's new Professional Knowledge and Innovation Manager, when they start in post. For now, have a fantastic summer...

*Usman Lula*

**Usman Lula**  
Chair of IPEM Scope EAB

In this special issue, we decided to focus on the pre-clinical and clinical use of artificial intelligence

**W**elcome to our summer issue of *Scope*! With UK lockdown restrictions easing further, and vaccinations taking place at a blistering pace, this is perhaps a special moment to reflect on all the technological developments we may have contributed to during the lockdowns.

In this special issue, we focus on the pre-clinical and clinical use of artificial intelligence (AI). World War II was the initial trigger for scientists from various disciplines to seriously start sharing ideas around machine intelligence. And it wasn't until 1961 when the first robots started to replace humans on the assembly line. Since then humans have made great strides in this area of technology. Today we

not only have intelligent virtual assistants, chat bots, cars and machines beating world champions at their own games, we have also started to employ the use of machine learning in scientific and clinical applications.

Of course, AI is still in its infancy in some of the areas of medical physics and clinical engineering, though in several areas it has matured enough to be adopted more widely.

Our Big Debate for this issue on "integration and innovation" has been kindly brought to us by IPEM's Communications team, and features a panel of four special guests discussing the Government's

## STRATEGY

### Wealth of expertise

You may recall that we advertised a couple of Commissioning Editor vacancies on our *Scope* Editorial Advisory Board in

the last few months. We are delighted to announce we have now filled these vacant positions. Both Clara Ferreira and Ejay Nsugbe bring with

them a wealth of experience, so we hope to provide even better coverage in *Scope* over the coming issues. We have already had our initial introductory meeting – where, amongst other things, we

discussed *Scope* strategy, as well as the possible themes for the December 2021 issue. What would you like for a theme in *Scope*? If you have an idea for a theme, then we would like to hear from you!



## IPEM Institute of Physics and Engineering in Medicine

Scope is the quarterly magazine of the Institute of Physics and Engineering in Medicine

IPEM Fairmount House, 230 Tadcaster Road, York, YO24 1ES  
T: 01904 610821 | F: 01904 612279  
office@ipem.ac.uk | ipem.ac.uk | scopeonline.co.uk

Chair of IPEM Scope Editorial Advisory Board: **Usman I. Lula**  
Principal Clinical Scientist, 1st Floor, Radiotherapy, Building,  
Medical Physics – University, Hospitals Birmingham NHS  
Foundation Trust, Queen Elizabeth Hospital, Queen Elizabeth  
Medical Centre, Birmingham, UK B15 2TH  
0121 371 5056 | usman.lula@uhb.nhs.uk

Vice Chair of IPEM Scope Editorial Advisory Board: **Dr Matt Aldridge**  
Clinical Scientist Radiotherapy Physics/Nuclear Medicine, UCLH  
matthewaldridge@nhs.net

Commissioning Editor  
**Ejay Nsugbe**

Commissioning Editor, Reviews: **Usman I. Lula**  
0121 371 5056 | usman.lula@uhb.nhs.uk

Commissioning Editor, Applied Academics: **Vacant position**

Commissioning Editor  
**Clara Ferreira**

Commissioning Editor, Medical Physics: **Usman I. Lula**  
0121 371 5056 | usman.lula@uhb.nhs.uk

Commissioning Editor, Medical Physics: **Dr Paul Doolan**  
Medical Physicist, German Oncology Center,  
1 Nikis Avenue, 4108 Agios Athanasios, Limassol, Cyprus  
00357 2520 8025 | paul.doolan@goc.com.cy

Commissioning Editor, Clinical & Biomedical Engineering:  
**Vacant position**

Scope is published on behalf of the  
Institute of Physics and Engineering in Medicine (IPEM) by

Redactive Publishing Ltd  
+44 (0)20 7880 6200  
redactive.co.uk



Publisher: Daniel Butcher  
daniel.butcher@redactive.co.uk | +44 (0)20 7324 2728

Editor: Rob Dabrowski

Lead designer: Carrie Bremner

Picture researcher: Claire Echavarry

Production: Aysha Miah-Edwards  
aysha.miah@redactive.co.uk | +44 (0)20 7880 6241

Advertising sales:  
scope@redactive.co.uk | +44 (0)20 7880 7556

Scope is published quarterly by the Institute of Physics and Engineering in Medicine but the views expressed are not necessarily the official views of the Institute. Authors instructions and copyright agreement can be found on the IPEM website. Articles should be sent to the appropriate member of the editorial team. By submitting to Scope, you agree to transfer copyright to IPEM. We reserve the right to edit your article. The integrity of advertising material cannot be guaranteed.

Copyright: Reproduction in whole or part by any means without written permission of IPEM is strictly forbidden. © IPEM 2021. ISSN 0964-9565



### FEEDBACK

Discuss, debate, share.  
[mycommunity.ipem.ac.uk/login](https://mycommunity.ipem.ac.uk/login)



### WEBSITE

News, events, support.  
[ipem.ac.uk](https://ipem.ac.uk)



### ARCHIVES

Back issues of Scope online.  
[bit.ly/2SRhh0E](https://bit.ly/2SRhh0E)

# GO



# 14

## CLINICAL

### 14 / THE BIG DEBATE: INTEGRATION AND INNOVATION

In April IPEM President-Elect Robert Farley chaired a panel of four experts in a virtual roundtable on the government policy paper *Integration and innovation: working together to improve health and social care for all*. Here are a selection of insights from the debate.

**I like the pleasing pragmatism of the white paper, and the language and honesty of it is quite refreshing.**

– Robin Mark McDade [page 14](#)

### UPFRONT

03 / CHAIR'S COMMENT

07 / NEWS

10 / TECHNOLOGY NEWS

12 / POLICY UPDATE

Cover image by  
**MARIO WAGNER**



# 22

# CONTENTS

## COVER FEATURE

### 18 / A STEP INTO THE UNKNOWN

Artificial intelligence is already changing the clinic, write Professor Chris Moore and Dr Mike Nix, and now the health system is gearing up for a big change.

## GENERAL

### 22 / WOMEN PHYSICISTS OF THE ROYAL FREE

A historical account of the trailblazing women of the Royal Free Hospital Medical School.

### 25 / AUTO-CONTOURING FOR RADIOTHERAPY

A look at the implementation and evaluation of automatic contouring for prostate and pelvis radiotherapy treatment planning.

### 28 / WHAT DOES THE UK-EU DEAL MEAN FOR SCIENCE?

Analysis of a virtual meeting to discuss the implications for science of the UK-EU deal.

### 30 / CYBERTRON AND THE PHANTOM

Intelligent cybernetics for self-learning of phantom motion intent from neuromuscular and brainwave bio-signals.



## MEDICAL PHYSICS

### 33 / DATA CURATION AND BIAS

Clinical Scientist Rollo Moore on balancing user and vendor responsibilities in statistical learnt strategy systems.

### 36 / ARTIFICIAL INTELLIGENCE IN RADIOLOGY

Philip Cosgriff and Matthew Memmott describe the main potential areas of the application of artificial intelligence in radiology and nuclear medicine.

### 40 / SHOULD YOU TRUST A COMPUTER TO TELL YOU IF YOU HAVE CANCER?

How to separate marketing hype from modernising clinical practice in the ever-changing world of artificial intelligence and machine learning.

### 44 / MOLECULAR IMAGING RESEARCH

Dr Laurence Vass and Professor Phil Blower look at the latest developments and future possibilities in molecular imaging research.

### 44 / AI IN NUCLEAR MEDICINE

Principal Clinical Scientist Sofia Michopoulou looks at some of the different uses for artificial intelligence in nuclear medicine.

## ENDNOTES

### 50 / A CHALLENGING YEAR IN ITALY

Eduardo José Florian Ché from Guatemala is IPeM's International Scholar. Here he gives a personal account of his year studying in Trieste.

### 52 / OBITUARY: JOHN ROWLAND MALLARD

Professor Peter Sharp OBE, Emeritus Professor of Medical Physics at the University of Aberdeen, pays tribute.

### 54 / BOOK PITCH: MODELS OF THE MIND

Computational neuroscientist Grace Lindsay outlines the ideas behind and the content within her new book.

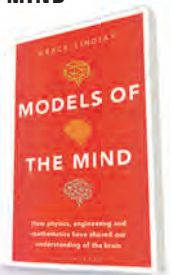

# ART-Plan™

Unlocking the full potential of radiotherapy with **Artificial Intelligence**

ART-Plan Annotate brings AI into the planning workflow of OAR and nodal auto-contouring using state-of-the-art advancements in artificial intelligence, data science and medical image processing.

- Time savings from AI-fuelled work-flow automation and acceleration
- Integration into any radiotherapy environment including ProSoma
- Continuously improving results as algorithms learn from expert delineations globally



Contact OSL to arrange a demo.

**Oncology Systems Ltd**  
+44 (0)1743 462694  
enquiry@osl.uk.com  
[osl.uk.com](http://osl.uk.com)



## Dosimetry Solutions from Phoenix Dosimetry Ltd

The UK Distributor for Thermo and specialists in Dosimetry Equipment and 'Harshaw TLD Systems'.



### NEW TruDose EPD Electronic Personal Dosimeter

- Dose and Dose rate display/alarms for Hp10 and Hp0.07
- Use either stand alone or with RadSight software for full personal database and backwards compatible with EPD Mk2



Patch Panels for bunkers improve cable management, simple to install, custom made Dosimetry Cables: Any length, any connector, now with 2 year warranty

RadEye B20 measures Alpha, Beta, Gamma surface contamination with optional H\*10 filter and B-20 then becomes a dose/doserate meter



### Bart's Solid Water and Phantoms

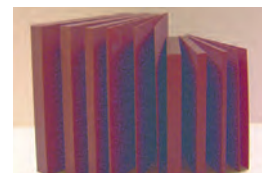

Ionisation Chambers 0.6cc NE2571/NE2581 and NPL-2611 Secondary Standard



Fast Repair Service: typically 1-2 weeks for Mini and Legacy NE/Thermo Equipment. Free inspection service with no obligation quote

Please visit our new website [phoenix-dosimetry.co.uk](http://phoenix-dosimetry.co.uk) or call 01252 871990

**FEEDBACK**

Discuss, debate, share  
[my.community.ipem.ac.uk](https://my.community.ipem.ac.uk)

**WEBSITE**

News, events, support  
[ipem.ac.uk](https://ipem.ac.uk)

# UPFRONT

**BIOMEDICAL ENGINEERING**

## Wireless brain-computer interface

**F**or the first time, human use of a high-bandwidth wireless brain-computer interface (BCI) has been demonstrated.

BrainGate clinical trial participants with tetraplegia have used the intracortical wireless BCI with an external wireless transmitter.

The system is capable of transmitting brain signals at single-neuron resolution, in full broadband fidelity without physically tethering the user to a decoding system.

The traditional cables are replaced by a small transmitter about two inches in its largest dimension and weighing a little over 1.5 ounces.

The unit sits on top of a user's head and connects to an electrode array within the brain's motor cortex using the same port used by wired systems.

For a study, two clinical trial participants with paralysis used the BrainGate system with a wireless transmitter to point, click and type on a standard tablet computer.

The study showed that the wireless system transmitted signals with virtually the same fidelity as wired systems, and participants achieved similar point-and-click accuracy and typing speeds.

John Simeral is an Assistant

**People no longer need to be physically tethered to our equipment, which opens up new possibilities**

Professor of Engineering (Research) at Brown University, a member of the BrainGate research consortium and the study's lead author.

He said: "We've demonstrated that this wireless system is functionally equivalent to the wired systems that have been the gold standard in BCI performance for years."

"The signals are recorded and

transmitted with appropriately similar fidelity, which means we can use the same decoding algorithms we used with wired equipment. The only difference is that people no longer need to be physically tethered to our equipment, which opens up new possibilities in terms of how the system can be used."

[bit.ly/3gMj6Zq](https://bit.ly/3gMj6Zq)

**FAST FACTS****2 PARTICIPANTS**

There were two trial participants – a 35-year-old man and a 63-year-old man, both paralysed by spinal cord injuries

**48 MEGABITS**

Two devices used together recorded neural signals at 48 megabits per second from 200 electrodes

**36 HOURS**

The research showed the devices have a battery life of more than 36 hours

ORTHOPAEDIC MEDICINE

# AI to detect wrist fractures



**A**n automated system that uses artificial intelligence (AI) is effective at detecting scaphoid fractures on X-rays, it is claimed.

Researchers said the AI-derived algorithm could help speed diagnosis and allow earlier treatment.

The system had a sensitivity of 78% for detecting fractures with a positive predictive value of 83%, which refers to the likelihood that patients the AI identifies as having a fracture really do have one. Analysis showed that the system performed comparably to 11 radiologists.

Conventional X-ray is often limited by overlap of the scaphoid with the surrounding bones of the wrist. Variations in wrist positioning and X-ray

technique can also limit the visibility of fractures.

The new system, which is based on deep learning with a convolutional neural network, could aid radiologists in detecting these common fractures.

While previous research found that a convolutional neural network was inferior to human observers at identifying scaphoid fractures on X-rays, the new study used larger datasets and refined algorithms to improve detection.

It also employed class activation maps – AI tools that help users understand what region of the image is influencing the network’s predictions.

The researchers used thousands of conventional X-rays of the hand, wrist and scaphoid to develop the system.

[bit.ly/3aKxsWk](https://bit.ly/3aKxsWk)

MICROSCOPY

## ULTRAFAST ULTRASOUND

Researchers have performed the first microscopic mapping of the vascular network in the human brain.

The team, from Physics for Medicine Paris, used transcranial ultrafast ultrasound localisation microscopy (ULM) of intravenously injected microbubbles to capture intracranial blood flow dynamics with a resolution of around 25 µm.

This could help expand the fundamental understanding of brain haemodynamics and shed light on how vascular abnormalities in the brain are related to neurological diseases and disorders.

The research team details its

method – ultrasound localisation microscopy – in *Nature Biomedical Engineering*.

They wrote: “Here we show that ultrafast ULM of intravenously injected microbubbles enables transcranial imaging of deep vasculature in the adult human brain at microscopic resolution and the quantification of haemodynamic parameters.

“Ultrafast ultrasound localisation microscopy may facilitate the understanding of brain haemodynamics and of how vascular abnormalities in the brain are related to neurological pathologies.”

[go.nature.com/2QvjegH](https://go.nature.com/2QvjegH)

NEWS IN BRIEF

## MRI concept

A promising new concept paves the way for advances in the field of magnetic resonance imaging (MRI). The new technique could significantly simplify hyperpolarised MRI, which was developed around 20 years ago for observing metabolic processes in the body. The proposal involves the hyperpolarisation of the metabolic product fumarate using parahydrogen and the subsequent purification of the metabolite.

[bit.ly/3nuPUaD](https://bit.ly/3nuPUaD)

## Radiation protection

The UK Government published new guidance in April – *How we regulate radiological and civil nuclear safety in the UK*. This document sets out the UK’s legislative and regulatory approach for radiological and civil nuclear safety. It is intended to provide a guide to the UK’s comprehensive safety framework in one place. It includes a section on medical and non-medical exposures.

[bit.ly/3u2xL6L](https://bit.ly/3u2xL6L)

## Bio-artificial arteries

Researchers at the University of Strathclyde have received £377,000 from the Medical Research Council (MRC) to develop a bio-artificial artery to treat cardiovascular diseases. The MRC New Investigator Award won by Dr Junxi Wu, Chancellor’s Fellow in the Department of Biomedical Engineering, will enable him to lead a multidisciplinary team with expertise in vascular biology and bioengineering to develop a bio-artificial artery that mimics the natural artery.

[bit.ly/3voGBfi](https://bit.ly/3voGBfi)

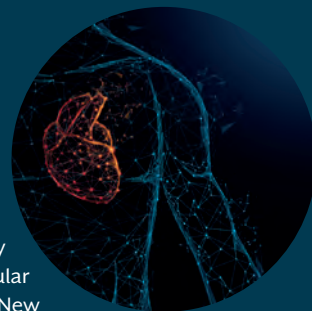



## WEARABLES

# Cytokine storm sweat sensor

Early in the COVID-19 pandemic, doctors recognised that patients who developed a “cytokine storm” – a surge of pro-inflammatory immune proteins – were often the sickest and at highest risk of dying.

However, a cytokine storm can also occur in other illnesses, such as influenza. Scientists have now reported preliminary results on a sweat sensor that acts as an early warning system for an impending cytokine storm,

which could help doctors more effectively treat patients.

The researchers presented their results at the spring meeting of the American Chemical Society in April.

Shalini Prasad, the project’s principal investigator, said: “Especially now in the context of COVID-19, if you could monitor pro-inflammatory cytokines and see them trending upwards, you could treat patients early, even before they develop symptoms.”

Early detection is important

because once a cytokine storm has been unleashed, the excessive inflammation can damage organs, causing severe illness and death. If doctors could administer steroidal or other therapies as soon as cytokine levels begin to rise, hospitalisations and deaths could be reduced.

For their new cytokine sensor, the researchers made sensor strips with antibodies against seven pro-inflammatory proteins.

🔗 [bit.ly/3aOPkjo](https://bit.ly/3aOPkjo)

## UP CLOSE

### SHEAR WAVE ELASTOGRAPHY (SWE)

#### WHAT IS SHEAR WAVE ELASTOGRAPHY (SWE)?

An innovative type of ultrasound scan that can detect cancer tissue left behind after a brain tumour is removed.

#### HOW WOULD IT BE USED?

During brain surgery to detect residual cancerous tissue, allowing surgeons to remove as much as possible. There are hopes that it could improve the outcome from operations and reduce the risk of relapse.

#### HOW HAS SWE BEEN TESTED?

A research team led by the Institute of Cancer Research and the National Hospital for Neurology and Neurosurgery in London compared, in a sample of 26 patients, three different techniques to detect tumour tissue during surgery: shear wave scans, a standard 2D ultrasound, and a

surgeon’s opinion.

The researchers performed shear wave scans and 2D ultrasounds during the operation – before, during and after tumour removal.

#### ANYTHING ELSE?

Yes, they also asked surgeons to identify potentially cancerous tissue before providing them with scan findings. The team then compared all techniques with gold-standard MRI scans after surgery.

#### WHAT DID THEY FIND?

SWE was more sensitive in detecting residual tumour tissue than a standard ultrasound or the surgeon alone. The new scanning technique detected tumour tissue with 94% sensitivity compared to 73% for standard ultrasound and 36% for the surgeon.

🔗 [bit.ly/2Sf8F6j](https://bit.ly/2Sf8F6j)

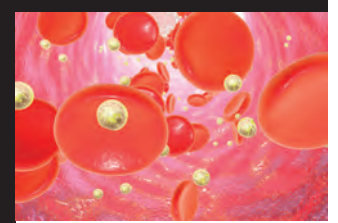
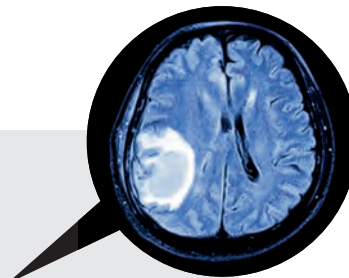

## BIOTECHNOLOGY

### GOLD NANOPARTICLES AND DIAGNOSTICS

Scientists have developed a novel implantable sensor that can continuously transmit information on vital values and concentrations of substances or drugs in the body for several months.

The sensor is based on colour-stable gold nanoparticles modified with receptors for specific molecules.

The nanogold is implanted under the skin where it reports changes in drug concentrations by changing its colour.

Gold nanoparticles act as small antennas for light: they strongly absorb and scatter it and, therefore, appear colourful. They react to alterations in their surrounding by changing colour. The research team exploited this concept for implanted medical sensing.

To prevent the tiny particles from swimming away, or being degraded by immune cells, they are embedded in a porous hydrogel. Once implanted under the skin, small blood vessels and cells grow into the pores. The sensor is integrated in the tissue and is not rejected as a foreign body.

🔗 [bit.ly/3aQTM0I](https://bit.ly/3aQTM0I)

**CLINICAL TRIALS**

## MRI CANCER DETECTION

The US Food and Drug Administration has approved human clinical trials to test the safety of a new cancer-detection technology.

It is a tumour-targeting contrast agent that detects aggressive prostate cancer in a magnetic resonance imaging (MRI) scan.

The molecular-targeted imaging agent was developed at Case Western Reserve University and is licensed to Cleveland-based start-up Molecular Theranostics and its partners.

The agent will undergo a clinical trial, with patient recruitment having started in early May.

The imaging agent, known as MT218, was invented in the lab of Case Western Reserve researcher Zheng-Rong Lu, who has been developing the tumour-specific MRI contrast agent for nearly 15 years.

Lu, a co-founder of Molecular Theranostics, and his partners believe the agent could someday allow clinicians to non-invasively and accurately diagnose the malignant prostate cancer in a common MRI scan.

A more precise MRI scan of prostate cancer – and possibly other cancers – could benefit patients who are sometimes treated with aggressive interventions, or conversely, better identifying those who need treatment.

☎ [bit.ly/3xx1h6D](https://bit.ly/3xx1h6D)

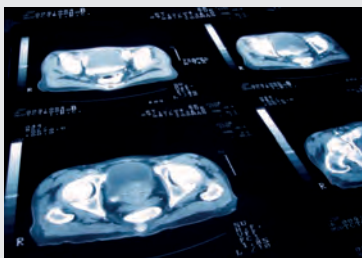

**BIOTECHNOLOGY**

## 3D analysis of biomechanics

**A** joint industry project to advance markerless 3D analysis of biomechanics for medical and sports applications has been launched.

The Markerless Motion Capture Joint Industry Project (M2CJ) will leverage the SwRI-developed BIOCAP technology.

BIOCAP measures human motion using machine vision, artificial intelligence, deep learning, sensor fusion and biomechanical modelling.

Kase Saylor, Co-director of SwRI's Human Performance Initiative, which developed the BIOCAP system, said: "M2CJ will enable cost-effective precompetitive research and system development through a collaborative forum.

"Industry professionals can get more insights by using one of the most accurate markerless biomechanics tools available."

Markerless motion capture leverages computer vision algorithms to circumvent attaching physical body markers to a human subject to capture 3D motion data

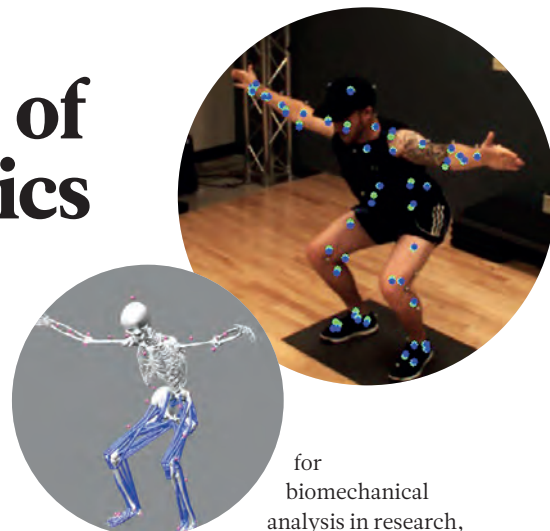

for biomechanical analysis in research, clinical and sport science applications.

SwRI's BIOCAP uses off-the-shelf cameras and custom machine learning algorithms to quantify musculoskeletal biomechanical performance related to walking, running, sports and other precise physical movements.

It generates large amounts of biomechanically accurate training data using a combination of biomechanics and machine vision techniques.

A cross-validation artificial intelligence training and characterisation method quantifies the system's accuracy.

☎ [bit.ly/2PwhkR7](https://bit.ly/2PwhkR7)

**3D PRINTING**

## SELF-HEALING SOFT MATERIALS

Scientists have demonstrated for the first time the possibility of manufacturing hydrogels with complex architectures capable of self-healing following a laceration, thanks to 3D printing activated by light.

Hydrogels are polymeric materials that contain a large amount of water and have the potential to reproduce the features of biological tissues – something

particularly significant in the field of regenerative medicine.

Previous hydrogels were created in the lab with either self-healing properties or were modellable in complex architectures using 3D printing.

However, the new research demonstrates both features: architectural complexity and the ability to self-heal following damage.

The hydrogel was created using materials available on the market and processed using a commercial printer, making the approach extremely flexible and potentially applicable anywhere.

## IN-HUMANS STUDY

# Novel PET radiopharmaceutical

**T**he preliminary trial results of a novel radiopharmaceutical for PET imaging of inflammation have been published.

The compound, which targets the vascular adhesion protein 1 (VAP-1) that regulates inflammatory cell traffic, is the first radiopharmaceutical that has been developed completely in Finland and has advanced to clinical trials.

In the study that started with healthy volunteers, the radiopharmaceutical was found to be well tolerated and safe.

The radiopharmaceutical is  $^{68}\text{Ga}$ -labelled Siglec-9 peptide.

The study included the imaging of a patient with early rheumatoid arthritis. The inflamed joints were clearly visible

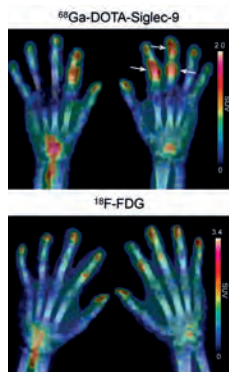

in the PET images, and the radiopharmaceutical seems to effectively target inflamed tissue.

Professor Anne Roivainen from the University of Turku said: “Our radiopharmaceutical is a product of long-term preclinical research work, and it is rewarding to see

results that match our expectations.

“The research results are promising, but all novel radiopharmaceuticals must fulfil strict medical and statistical criteria before they can be considered for general research use. Therefore, we will continue the study with voluntary rheumatoid arthritis patients.”

[bit.ly/3elhLQZ](https://bit.ly/3elhLQZ)

## BIOCHEMISTRY

# New diagnostic platform

Scientists claim to have now paved the way for a completely new diagnostic platform.

LEOPARD is a CRISPR-based method that is highly multiplexable, with the potential to detect a variety of disease-related biomarkers in just one test.

LEOPARD stands for Leveraging Engineered tracrRNAs and On-target DNAs for PARallel RNA Detection.

It is based on the finding that DNA cutting by Cas9 could be linked to the presence of a specific ribonucleic acid (RNA).

This link allows LEOPARD to detect many RNAs at once, opening opportunities for the simultaneous detection of RNAs from viruses and other pathogens in a patient sample.

Chase Beisel, a Professor at Julius Maximilians University (JMU) in Würzburg, said: “With LEOPARD, we succeeded in detecting RNA fragments from nine different viruses. We were also able to differentiate SARS-CoV-2 and one of its variants in a patient sample while confirming that each sample was correctly collected from the patient.”

Oliver Kurzai, Director of JMU’s Institute of Hygiene and Microbiology, which provided patient samples for the study, said: “In the future, LEOPARD’s performance could dwarf even multiplexed PCR tests and other methods.

“The technology has the potential to revolutionise medical diagnostics not only for infectious diseases and antibiotic resistances, but also for cancer and rare genetic diseases.”

[bit.ly/3dY5DfQ](https://bit.ly/3dY5DfQ)

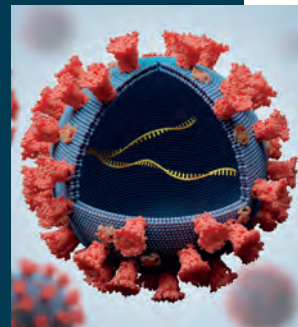

IMAGES: OLLIMORSIO / SHUTTERSTOCK / ISTOCK / ALAMY

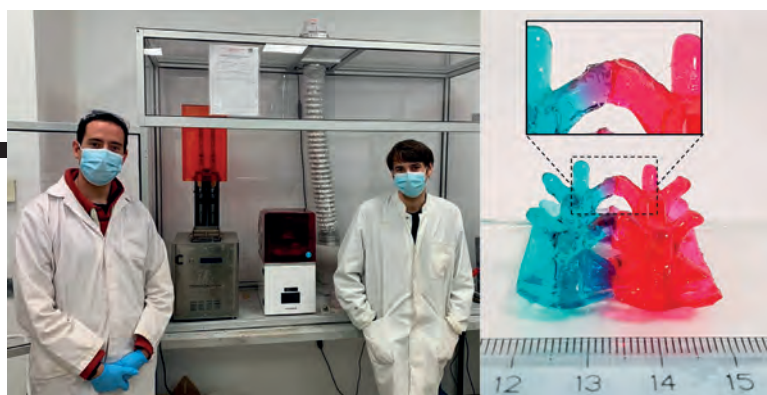

It is claimed that this opens new possibilities for development both in the biomedical and soft-robotics fields.

The scientists behind the development say the research represents a first step towards

the development of highly complex devices, which can exploit both the complex geometries and the intrinsic self-healing properties in various application fields.

[go.nature.com/3voDB2s](https://go.nature.com/3voDB2s)

**EXTERNAL RELATIONS MANAGER**

# Reviews, consultations and virtual meetings

**Sean Edmunds**, the Institute's External Relations Manager, outlines the latest policy news and institute updates.

Following the Brexit deal which was agreed almost on the stroke of New Year, the Parliamentary and Scientific Committee held a meeting to discuss the implications it could have for science. Professor Adam Gibson, IPEM's Vice President Academic, and Dr Richard Axell, Vice President External, attended this virtual meeting and you can read what they think the deal means for science on page 28 of this edition of *Scope*.

Professor Gibson also attended a meeting of the Campaign for Science and Engineering Horizon Europe Association, which looked at how the future relationship between the UK and the EU will work in practice for UK researchers and organisations.

Dr Axell also contributed to an IPEM response to the All Party Parliamentary Group on Diversity and Inclusion in the STEM Workforce, together with Dr Robert Farley, IPEM's President Elect, and Dr Anna Barnes. You can

read the Institute's submission by visiting the IPEM website at News & External Affairs > Consultations.

The National School of Healthcare Science launched a review of the Scientist Training Programme core curriculum, which individual members responded to, and Dr Emma Bowers, Director of the Professional and Standards Council, also responded on behalf of IPEM. Shortly after this, the

Members were encouraged via the COIs to respond to a Skills for Health survey



## INTEGRATION AND INNOVATION

A White Paper was published by the Department of Health and Social Care setting out proposals for a Health and Care Bill, entitled *Integration and innovation: working together to improve health and social care for all*.

IPEM brought together a panel to discuss the

proposals in the White Paper and how they might impact on medical physicists, clinical and biomedical engineers and technologists, as well as some of the issues it raised, such as funding, service integration, registration and regulation, and workforce planning.

The panel included

Angela Douglas MBE, the Deputy Chief Scientific Officer for NHS England and NHS Improvement, Dr Robert Farley, IPEM's President Elect and Head of MPCE at Leeds Teaching Hospitals NHS Trust, Dr Anna Barnes, Principal Clinical Scientist (Medical Physics) at University College Hospital, London,

Robin Mark McDade, Advanced Specialist Clinical Technologist at Glasgow Royal Infirmary, and Nick Gulliver, Chief Technologist (Nuclear Medicine and PET-CT) at King's College Hospital London.

You can read their thoughts on page 14 of this edition of *Scope*.



National School then called for views on the specialist curriculum review, which individual members responded to. Given the relatively short response time to this second review, Professor Stephen O'Connor, IPEM's President, wrote to the Head of the National School to ask for a short extension to the deadline to allow more time for IPEM to formulate a response to this but the request was turned down.

Members were also encouraged via the Communities of Interest (CoIs) to respond to a Skills for Health Healthcare Science Apprenticeships survey. The call went out to members who

are involved in recruitment and/or training to respond directly to this survey.

The Quality Review Service, on behalf of the College of Radiographers and the Royal College of Radiologists,

completed a revision of the Quality Standard for Imaging and called for views on it.

IPEM had been heavily involved in the draft revision. Members were once again asked via the relevant CoIs to respond to this, and the Magnetic Resonance Special Interest Group (SIG) and Ultrasound and Non-Ionising Radiation SIG also responded.

At the time of writing, two further consultations were being considered by IPEM to respond to, one from the Home Office concerning the safety of radiation sources, and the second from the Department of Health and Social Care to reform the regulation of healthcare professionals. ◉

## THE MEETING LOOKED AT THE FUTURE RELATIONSHIP BETWEEN THE UK AND THE EU AFTER BREXIT

## Radiation & RF Shielding, MR & X-ray Imaging Accessories

- Structural X-ray & Gamma Shielding
- RF & Magnetic Shielding for MRI
- MRI Patient Monitoring
- Bespoke Engineering
- Exports  
Agents in over 40 countries

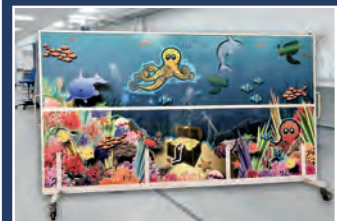
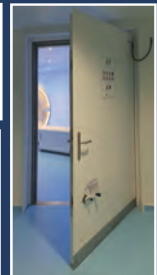

T • +44(0) 20 8398 9911  
 F • +44(0) 20 8398 8032  
 E • sales@wardray-premise.com  
 W • www.wardray-premise.com

**WARDRAY  
PREMISE**

*Quality without Compromise from the UK's leading radiation shielding company*

IMAGE: ISTOCK

# THE BIG DEBATE

## Integration and innovation

In April, IPEM President-Elect Robert Farley chaired a panel of four experts in a virtual roundtable on the government policy paper *Integration and innovation: working together to improve health and social care for all*. Here are a selection of insights from the debate.

### Q How will the White Paper proposals affect IPEM members?

**ANGELA DOUGLAS**

We created a national clinical engineers forum last year that's become a community of practice, and all the innovative practices they've adopted have been recognised in this paper. Some of these innovations are changes we want to see accelerated as part of our new ways of working, and the paper provides both a framework that allows for this further evolution, and to sustain all the innovation we've seen during this pandemic. So I think the White Paper will benefit our medical physicists and clinical engineers because it recognises the way they've been working this year. It will help embed innovation into good practice going forward. Importantly, the White Paper highlights how

our clinical systems do need to be led in a multi-professional way. This is to hold our clinical systems to account, to ensure our healthcare scientists are involved in any transformation that is going to be led through integrated care systems. Ultimately, because we believe our healthcare scientists are really important to diagnostics – we deliver 80% of them across the NHS – we believe our voices need to be heard.

**NICK GULLIVER**

Reading the paper, there is certainly a case for joining up and integrating care around patients rather than institutional silos. We have a duty to collaborate with each other too. This will mean integrated care systems will need an imaging network, to form collaborations with neighbouring trusts. On safety and quality, the White Paper is talking about bringing in measures to enable improvements in the current legislative landscape, for healthcare professionals, and particularly technologists. But this is a hot potato at the moment as clinical technologists are not under statutory regulation, unlike scientists (see later).

**ROBIN MARK MCDADE**

The White Paper does touch on issues impacting clinical technologists – such as role clarification. It's a perennial problem that technologists aren't on a statutory register, and it creates a layer of ambiguity about their frontline clinical role that hasn't really been settled. This paper begins to touch on this, while tackling bureaucracy and confusion. For instance, clinical technologists can work in nuclear medicine or move into radiography. But because a technologist doesn't have the statutory registration a radiographer has, moving from one trust to another still means things become a local negotiation about whether someone can practice. So if the paper delivers on this, it will be good for the workforce and patients. But there still needs to be clarity about the role of technologists.

**ANNA BARNES**

What I have found is that clinical scientists are a completely untapped workforce for delivering change. Our workforce though is fundamental. So to our members I would say take a look at this White Paper, think about how you already do innovation in your day-to-day work, and think how you would like to scale this up.





## Q *Is the patient's voice and choice heard and present in this White Paper?*

### ROBIN

I'm not sure they are, especially on concerns for safety that the paper expresses. For those patients who go for surgery, equipment will likely have been made safe by clinical technologists. None are on a statutory register. I think it's important to hear from patients about what they think about that sort of thing. I think patients don't really realise what

registration is but they should. Clinical technologists could be delivering a scan, or delivering radiotherapy. They all involve risk and they're all frontline, hands-on roles. They're currently only on a voluntary register. I don't think the public is aware of this issue.

### NICK

The White Paper doesn't say much on patient voice; it says more on patient choice – in terms of choosing where they will be treated. The problem is that NHS Employers can't enforce non-statutory legislation. It's not compulsory to join a voluntary register. Yet non-statutory registration doesn't afford enough protection to patients in a modern day healthcare environment. Given the complexity of chemical competencies required in the medicines field, this lack of regulation isn't sufficient to provide security to patients. With statutory registration there tends to be more scrutiny. Without it there is the opportunity for technologists who aren't as skilled to remain in the workforce, and potentially give sub-optimal care.

### ANGELA

I have a slightly different perspective. From our experience, we know patients want to be guided by healthcare professionals who are knowledgeable. They want to attend services driven by high-quality care. But they want to be involved in decision making around that high-quality care. Our systems are a driver of patient-centred approaches, and they value patients as decision makers. Our integrated care systems are being asked to protect, promote and facilitate this patient voice, so we don't just see our patients as a unit, but as a co-producer of the services that are going to be delivered. So I actually think there is a real opportunity to strengthen our patient voice at the local system level. I think there's always more work to be done, but we are able to see a joined-up approach is being taken. This is one that is very patient focused. We'll see more patient-led forums that will strengthen patient voice.

## MEET THE EXPERTS



### DR ANNA BARNES

Principal Clinical Scientist,  
Nuclear Medicine  
UCLH, and Honorary Associate  
Professor, Centre for Medical  
Imaging, UCL



### ANGELA DOUGLAS MBE

Deputy Chief  
Scientific Officer  
NHS England and NHS  
Improvement



### ROBIN MARK MCEADE

Advanced Specialist  
Clinical Technologist  
Glasgow Royal Infirmary



### NICK GULLIVER

Chief Technologist,  
Nuclear Medicine  
King's College Hospital NHS  
Foundation Trust

**Q** *Will the White Paper proposals help get funding to where it's needed most or hinder this?*

**ROBIN**

The proof is in the pudding. I'm not sure. I like the pleasing pragmatism of the White Paper, and the language and honesty of it is quite refreshing. I also like certain lines like 'led by those who know best' – the idea that healthcare leaders will be deciding. But I think it's the folk that deliver healthcare that needs to have a stronger voice, and we need to integrate them better into the decision-making process. But I'm really not sure. We've centralised services, but I'm not sure how this will play out.

**ANNA**

What I'd like to see is whether the funding can be used to break out of what we normally do, and have multidisciplinary community care teams that involve scientists as well as medics and nurses. We need to enable people to get the help they need closer to home. It needs to be easy too. It's scary going to hospital. If we can push some of this technology out into the community that's got to be a good thing. Maybe that brings us round to better training; to get to a better community care model to training schemes, but I don't know. Will there be enough funding? It depends how creative we can be in our own regions and integrated care systems.

**ANGELA**

I agree with everything Anna says. Every healthcare professional has a role to play. We need to plan the care of our future not by what we've done in the past. In this last year we've really brought innovation in fast. There will never be enough funding – let's get that straight. Even if we double it there will never be enough. It's like a bottomless pit. So we need to think about how we use this money more effectively.

We generate a lot of data, so we have a real potential to generate some significant health benefits. To do this, I say centralise where we need to centralise, but localise where we can improve the quality of patient care. I think the higher our patient satisfaction becomes, the more efficiently we used what funding we have. What the White Paper highlights is that with our integrated care systems and partnerships, we need to be making sure that our clinical engineers, and other scientists are part of this forum – one that is going to coordinate any action for alignment of funding. We also need to ensure that funding gets to where it's needed most, and that might not

necessarily be in a few trusts; it might be in our local care homes, or in hard-to-reach (rural) communities. For instance, why should our patients have to travel 200 miles to be seen? Where the White Paper will support what we've been talking about is in the changes to the tariff, which will enable that tariff to work more effectively in local system approaches – to allocate funding according to local needs, rather than have it dictated by national priorities. That's where I see the sea-change happening in this White Paper. It's about moving away from the national direction, to what's needed locally.

**Q** *How will we attract, retain and reward those considering our professions to address our urgent people needs?*

**ANGELA**

We've specifically been working with the NHS People Board and NHS England on the NHS People Plan. But it's not just a one-year thing, it's an ongoing long-term workforce strategy that's needed. It isn't specific for this particular workforce or for healthcare scientists, but what we need to do as a healthcare science profession, is have collaborative working with the Health Education England and the National School, to work through some of the recommendations of the plan. What we need to do is show the need for a flexible and future-proofed regional workforce operating model. We know that different regions have different workforce needs, and we've been





working on modelling, but we have yet to work through using the data. We're starting to do that now with Health Education England, but what we'd like each of our professional groups to do, is take the workforce data that's been developed, and we can look back, and model, so we can start to see where significant gaps are. We need to engage with that data so we can deliver real purpose in our workforce strategy. It's all about the data – we need to understand it, model it, and work with professional groups to address the gaps that we see looming in the future.

#### ROBIN

There are barriers that are structural and I don't think the White Paper addresses them. There's been a chronic shortage of practitioners coming through the practitioner training programme. Courses are unviable, because not enough people go through them. In my field, you can be in nuclear medicine and become a radiographer, and you would have government bursaries (of around £5k) – but if you do the Practitioner Training Programme (PTP), you don't get that level of support. So why would you bother then? People are economically disincentivised. A radiographer would be on a statutory register and would be recognised, but if you do the practitioner training programme, you won't be. We have real structural problems. The paper just doesn't address this. In our own national technology training scheme we ensure that what we deliver is up to date. But I know IPEM is trying to have dialogue with the national school to harmonise, so I hope there will be a collaborative approach taken.

**Q** *The White Paper's focus on integration extends into a push to give government greater powers to reconfigure the regulator landscape. This would, in practice, mean fewer regulators. Does this approach offer an opportunity to further make the case for clinical technologists to be statutorily registered?*

#### ANGELA

This is something I have been discussing in the office of the Chief Scientific Officer for some time now. What I would say is that registration of professions should be based on reviewing



those with risk and need for regulation. Bearing this in mind, what the paper does is reduce bureaucracy around regulation, because at the moment, bureaucracy actually creates barriers among those groups that need to be registered. I also think that if we reduce the number of regulatory bodies, this will actually aid the public's understanding of the wider regulation process, and it will also give our public greater assurance of who should and shouldn't be regulated. This would then give them a voice to support which professions should be regulated. That's where public understanding can actually push for these assurances. I know the paper says there might be a need to reduce the number of professions to be regulated, but I actually think we need to increase the amount of professionals being regulated, I think we need a process that is flexible though, to the new developing landscape. It's about reviewing based on risk and need for regulation.

#### NICK

I would say that there is a structural issue here. I might be saying something controversial here, but at the moment, modernising scientific careers seems to be predicated on this general move from being a practitioner to a clinical scientist. What this does however, is disincentivise technologists to think of themselves as being in a profession in its own right – that is, there's nothing ever said about 'advanced clinical technologists'. There seems to be this assumption that high-achieving technologists just want to go into scientific training. But that means they'll no longer be a technologist, and they'll be missed. The other problem is the big push for apprenticeships. We should be encouraging vacancies to be converted in apprenticeships. It's unfortunate there are very few undergraduate courses for clinical technologists, so we as a small workforce, with a smaller voice, do need to speak up and engage with educational establishments, to say we need you to create courses to develop the workforce we need for the future. ●

#### FURTHER RESOURCES

To watch the virtual roundtable, visit:  
● [bit.ly/IPEMBigDebate](https://bit.ly/IPEMBigDebate)  
To read the government policy paper, visit:  
● [bit.ly/IPEMgovWP](https://bit.ly/IPEMgovWP)

# A STEP INTO THE UN- KNOWN

## AI in medical physics and engineering

Artificial intelligence is already changing the clinic, write **Chris Moore** and **Mike Nix**, and now the health system is gearing up for a big change.

ILLUSTRATION: MARIO WAGNER



In June 2019 Simon Stevens, Chief Executive of NHS England, set out his vision for the NHS to become a world leader in artificial intelligence (AI) by 2024. The NHS sits on a vast trove of data, and technology is the key to unlocking its potential to drive the service forward in the 21st century.

AI is a set of techniques allowing computers to efficiently perform highly complex tasks that would require intelligence if a human were doing them. These include machine learning and deep learning, state-of-the-art techniques where the computer is fed many pre-classified images and learns the connections between features in the image and the final classification without human guidance. These techniques have

powerful potential when applied to medical images in diagnosis, image reconstruction, radiotherapy planning and other applications, allowing fast, accurate classification – even detecting subtle features that would go unnoticed by expert human observers.

### Early uptake

In some areas AI has already entered the clinic, albeit in a fragmented manner, but there are further applications on the horizon. A number of manufacturers and proprietary vendors include AI techniques with their latest products and devices across a broad range of applications.

In diagnostic imaging, AI can be used to aid diagnosis both in improving accuracy and sensitivity, and speeding up the processing of reporting. AI systems exist for a wide range of imaging modalities and conditions of interest.

Some noteworthy examples include the behold.ai system, capable of identifying ‘normal’ chest X-rays and which received CE marking in 2020. It has the potential to help the NHS make up to £100m per year in time savings. During the COVID-19 pandemic, AI systems were developed that are able to detect the disease in the lungs of patients from X-ray or CT scans.

For MRI, Siemens have developed an ‘MRI prostate biopsy’ tool, analysing the images from an imaging protocol using machine learning to produce a ‘suspicion map’ of the prostate. This suspicion map indicates regions where abnormalities are suspected and reducing the need for invasive procedures.

### FAST FACTS

## SIMON STEVENS' AI VISION

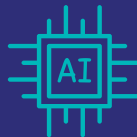

### 5 YEARS

The aim in 2019 was for the NHS to be a world leader in AI and machine learning within five years



### 30M

Exploiting the boom in AI technology will help to meet the NHS Long Term Plan's target of making up to 30 million outpatient appointments unnecessary



### £1BN

This would save over £1bn in what would have been increasing outpatient visits. The money can then be reinvested in frontline care, saving unnecessary journeys to hospital

AI can also be used in the image acquisition and reconstruction processes to improve image quality and accelerate imaging times. This is particularly useful in magnetic resonance imaging (MRI) where scanning is slow and movement artefacts can render an image unusable. AI has been used successfully to reconstruct images from under-sampled acquisitions, producing diagnostic images free from artefacts caused by the under-sampling process or movement in a fraction of the time. This has particular utility in cardiac cine imaging, allowing the cardiac cycle to be imaged in a single breath hold, improving image quality and patient comfort.

In radiotherapy planning, AI can be used to generate organ-at-risk contours and generate optimal beam delivery plans on a patient-by-patient basis. Manual planning represents a considerable bottleneck in the planning process. Current attempts to automate some of this process involve hard-coded 'class solutions' that have limited capability to adapt to patient specific variations. AI planning is currently in the pre-clinical phase but offers the potential to accelerate the planning process greatly.

There is also interest in generating synthetic computerised tomography (CT) planning images from MRI. MRI offers superior soft tissue contrast and is required for tumour delineation in many cases; however, the electron density information to create the treatment plan requires a CT image and the two images must be co-registered in the planning system. AI systems have been used to generate artificial CT images from MRIs in the head and pelvis. This reduces the errors in the co-registration process, reducing the number of visits the patient requires and sparing the radiation dose of the planning CT. The plans generated using these synthetic CTs have been observed to produce minimal dose differences compared with the traditional method.

### New uncertainties

While these techniques show great promise, they are also a step into the unknown. The apparent break between an observable cause and the resulting decision can lead to some unintuitive results. Before these systems can be deployed in the clinic, the results must be understood and the uncertainties explored. It is natural to be apprehensive of these unconventional methods, and scientific staff must be able to communicate AI's risks and benefits to clinical staff and patients. Medical physics and engineering personnel are ideally suited to introduce AI into the clinic with their expertise bridging the gap between the technical and the clinical, and their experience of maintaining and quality assuring current systems.

Human experts cannot be 100% accurate, so it is unreasonable to expect AI to be so. However, whatever the source of a decision, we must be appropriately confident in the outcome if it will be used to inform a clinical decision. Whereas human decision makers may have a sense of their errors, there is no such sense for AI and in the case where

## AN INCREASE IN DIAGNOSTICS

- The NHS is carrying out more diagnostic tests than ever before as part of efforts to tackle the major killers
- There were 315,000 MRI scans and more than 520,000 CT scans in March 2019 – an increase of 20% from 260,000 MRI in the same month three years ago, while CT scans were up a third from 390,000
- In mammography screening the NHS is performing around two million breast screens for women a year in the UK, with each test result reviewed by two clinicians
- Testing of AI and machine learning technology has already demonstrated its potential to ease the burden on staff and free them up for other work
- An AI system trialled at Moorfields Eye Hospital in London made the correct referral decision for over 50 eye diseases with 94% accuracy, matching the world's best eye experts
- NHS hospitals in England provide over 100 million outpatient appointments
- As set out in the Long Term Plan, the NHS is aiming to become the first national health system in the world to digitise its outpatients system through the use of video and online consultations and make use of AI and machine learning technologies to help clinicians interpret scans part of the NHS routine.



the AI comes from a proprietary vendor; it may effectively be a black box, preventing scrutiny of its methods. Furthermore, many subtle errors may go unnoticed by a human checker when looking at the AI prediction alone, without the ground truth to compare. Can we use an independent AI to check an AI prediction, to overcome these limitations?

### Gaining Confidence

The AutoConfidence system, developed by Dr Mike Nix at Leeds Teaching Hospitals NHS Trust, aims to answer this question by providing patient-specific quality assurance for AI-generated image-based predictions in radiotherapy planning. It uses an inverted generative adversarial network (GAN) where a 'generator' AI learns to make predictions that are convincing to a second 'discriminator' AI, which learns to detect predicted examples. The generator and discriminator compete until equilibrium is reached, improving both prediction quality and the ability to detect differences between predicted and real outputs. In contrast to normal practice, the generator is discarded and

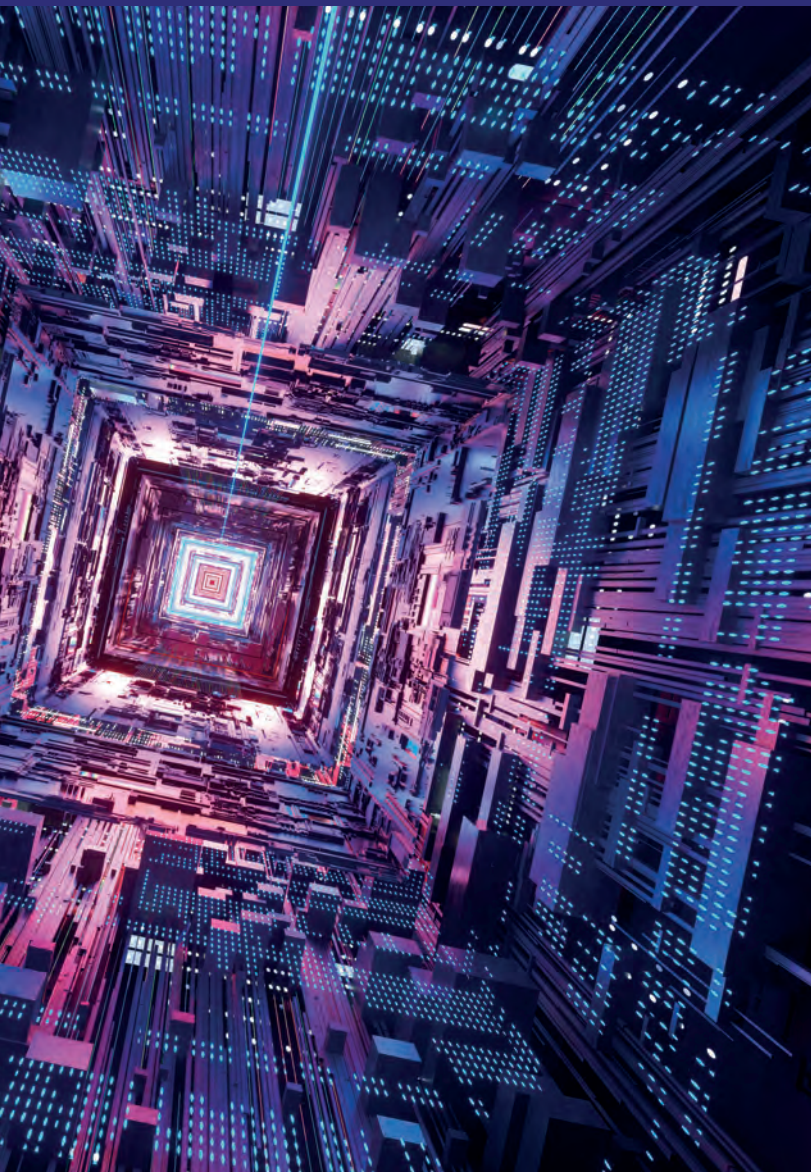

## AI EVERY EFFORT MUST BE MADE TO MAKE AI AS SAFE AND EFFECTIVE AS POSSIBLE

to flag for manual review areas of low confidence near high-dose regions or gradients – where errors could result in significant risks. This is expected to improve safety and allow significant time savings in review of AI-generated image predictions, enhancing the case for clinical implementation.

### Challenges and obstacles

Despite many exciting projects, the NHS still has a way to go in implementing the system-wide adoption of AI envisioned in Simon Stevens' 2019 speech (see box and *Fast facts*). A major obstacle to the uptake of the technology is one of education and training. Both patients and clinicians alike must be confident of the decisions made and systems must be easy to use and interpret. The physics and engineering community must take the lead in communicating the uncertainties and the clinical implications associated with AI. Another system-wide issue that must be addressed is one of IT policy and infrastructure. While those experienced with AI report that a lot can be done with standard PCs, it is incredibly difficult to access the required software with current NHS IT policies. Similarly, the success of AI relies on sharing large quantities of high-quality data. Here, policies restricting the sharing of data between trusts and the decentralised nature of data storage make this difficult. The physics and engineering community must work with policy-makers to ensure the full potential of AI can be harnessed by those on the ground.

### Conclusion

AI is already entering the clinic and will soon be widespread, transforming clinical practice. The medical physics and engineering community must not resist the change but learn to adapt to it. AI is eventually going to be involved in every clinical decision made, to some extent, so every effort must be made to make it as safe and effective as possible. From their unique position interacting with manufacturers, clinicians and management, the physics and engineering community must work at the highest levels to ensure the system works for everyone. ●

**Chris Moore** is a Trainee Clinical Scientist at the Christie NHS Foundation Trust. **Dr Mike Nix** is Principal Clinical Scientist (R&D) at Leeds Cancer Centre and DART-Ed Clinical Fellow at HEE and NHSx.

the discriminator is deployed to estimate the confidence of in-clinic predictions (from any source). Thus the system is independent of any AI system it may be used to validate.

AutoConfidence produces a confidence map for image-based predictions (segmentation or synthetic CT) of how likely it estimates each voxel to be equivalent to ground truth. This provides localised confidence for improved clinical decision-making.

The system was developed over through a one-year NHS Topol Digital Health Fellowship and was validated using a set of predictions and corresponding ground truth examples. The difference between the predictions and ground truth was compared to the confidence map produced by AutoConfidence without seeing the ground truth.

The system is now in the pre-clinical phase and has been used to evaluate AI-generated delineations and synthetic CTs. The confidence maps are currently used to identification of geometric or CT density errors, but will be combined with the calculated radiotherapy dose plan

IMAGE GETTY

# WOMEN PHYSICISTS OF THE ROYAL FREE

**Francis Duck** continues his account of the pioneers of medical physics with the stories of the trailblazing women of the Royal Free Hospital Medical School.



1 The entrance to the London School of Medicine for Women in Hunter Street

**D**uring the first half of the 20th century, three women led the physics department of the [London \(Royal Free\) School of Medicine for Women \(LSMW\)](#) (Figure 1).

They were:

**1. Edith Anne Stoney MA (1869-1938)**, privately-educated daughter of physicist Johnstone

Stoney, and a high-flyer in the Cambridge Maths Tripos. After leaving university and teaching for four years, she established the first physics department at the LSMW in 1898. I have written about her elsewhere (*Scope* Dec 2013, 48-54) and in *Edith and Florence Stoney, Sisters in Radiology*.

**2. Mary Désiré Waller BSc PhD (1886-1959)**, daughter of the acclaimed London physiologist Augustus Désiré Waller. She was educated at Cheltenham Ladies College and Bedford College London, where she gained her BSc in 1911. She was appointed by Edith Stoney as a part-time physics demonstrator and, after Edith's resignation in 1915, replaced her as physics lecturer (Figure 2).

**3. Winifred Agnes Leyshon BSc PhD (1890-1984)**, the only daughter of Rees Leyshon, headmaster of Wheatley National School in Oxfordshire. She gained scholarships to Oxford City Technical School, and then studied at Bedford College, graduating with a first-class BSc in 1910. After teaching in Bristol she was recruited to work



● Edith Stoney (second row L) and Mary Waller (second row R). LSMW staff photograph c. 1914. London Metropolitan Archives

were better suited to the dozen or so able students she taught at first. When WWI caused the student intake to grow in response to the gap left by male conscription, Edith's individual approach to teaching was no longer appropriate and she resigned.

Mary Waller was not much older than many of her students when she was appointed as lecturer in 1915. She had no previous teaching experience, apart from a brief period as physics demonstrator, and was faced with a surge in new students. She understood the importance of experimental work for understanding physics, and later published *Practical Physics for Medical Students* (1927), a book intended to help students with their own laboratory studies.

Winifred Leyshon, like Edith, brought teaching experience when she was appointed in 1920. She was an eloquent speaker and an excellent teacher. Both Winifred and Mary had a reputation for being extremely kind and patient with the students.

### Biomedical research

Teaching gave the bedrock for the department's work. However, there was also some time for research. Edith published little, and her particular contribution to clinical radiology occurred when she was working near the front line for the Scottish Women's Hospitals during WWI, when she demonstrated how gas gangrene could be diagnosed radiographically.

Mary Waller arrived with a strong medical and scientific pedigree. Her father, Augustus Désiré Waller, was the eminent physiologist perhaps best known for his demonstration in 1887 of the electrical activity of the

**II  
A PRECEDENT WAS  
SET THAT WAS  
FOLLOWED BY  
MEDICAL SCHOOLS  
IN THE SUBSEQUENT  
DECADES**

on short-range radio communications at the Royal Engineers Experimental Establishment at Woolwich. She joined Mary Waller in 1920, first as demonstrator and then lecturer.

I have split their story into three sections reflecting the three aspects of their careers: teaching, biomedical research and physics research.

### Teaching

Their job, first and foremost, was to teach physics to pre-clinical medical students. Edith's employment as a physicist on the medical school staff, without a medical degree, created a precedent. In 1898, such an arrangement was otherwise unknown. When physics became mandatory within

medical training during the 1890s, other medical schools used different approaches for its teaching. In some universities, the physics department continued to supply the lecturer. Some used one of their own medical staff with some knowledge of physics. The unusual decision at the LSMW to appoint a full-time physicist lecturer may have arisen because girls entering medicine were considered less likely to have studied maths and physics at school, and so, it was thought, needed more support. It set a precedent that would be followed by most British medical schools during the subsequent decades.

Edith founded the department, designed the course and set up the teaching laboratory. She set very high academic standards, which

heart using Lippmann's mercury capillary electrometer. In 1902 he had established London University's first physiological laboratory. It is unsurprising, therefore, to find Mary's first biomedical work in this area. In 'The emotive response of a class of 73 students of medicine, measured in correlation with the result of a written examination', published in *The Lancet* in 1918, she described the use of the so-called 'psycho-galvanic reflex' to evaluate her students' reactions to a variety of stress stimuli. These included an unexpected noise and a threatened or actual burn. The reactions were then compared with the pooled outcomes of written examinations. She concluded that 'intellectual efficiency is in some degree associated with higher nervous sensitiveness'. The topic formed the main theme in a course of lectures the same year that she presented with her father.

The Royal Free was never one of the leading radium centres in London, and it is unclear how close Mary Waller's group in the medical school became to these clinical developments in the hospital. Instead, there were plenty of other topics in biomedical physics. Working with Dr Mackenzie Shattock from the 'light department' Mary investigated erythema caused by UV exposure. In another study she investigated the temperature rise in surgical diathermy, neatly using the RF electrode as one pole of the thermocouple.

Winifred Leyshon similarly involved herself with biomedical research. In 1929 she designed and built a circuit for the stable, repetitive stimulation of muscles, designed around a neon discharge tube (Figure 6). She worked in the physiology laboratory with Lady Grace Briscoe, a surgeon who had also



● Mary Waller demonstrating Chladni figures for BBC television, 1937

30 papers describing her work on Chladni figures. Her technique was to cause a free plate to vibrate by touching it with solid carbon dioxide, visualising the plate vibration using sand. She had the persistence and understanding to develop what was otherwise a scientific parlour trick, and her analysis of the many modes of vibration

taken part in the radium trials. The work was funded by the Waller Memorial Research Fund, set up following the deaths of both Mary's parents in 1922.

### Physics research

In spite of the placement of the physics department in a medical school, Mary Waller and Winifred Leyshon saw their professional home to be within the physics community. Both became Fellows of the Institute of Physics. Both defended PhD theses with non-medical topics. When the Hospital Physicists' Association was founded in 1943, they joined their male physics colleagues as founder members. Stemming from this broader horizon, the majority of the publications of both women were in areas of physics outside biomedical applications. Winifred Leyshon was an electronic engineer. Not in the professional sense, but because her PhD, completed in 1923, was on electronic oscillator design. She studied with the wireless pioneer William Eccles, head of physics at Finsbury College. They took out a joint patent on mechanical stabilisation of

oscillators. Winifred went on to publish seven further papers on oscillator design. Her role as a pioneer woman in bioengineering deserves greater acknowledgement.

Mary Waller's 'extra-curricular' papers were even more extensive. From 1932 until 1957 she published over

of plates of a variety of shapes was sufficient to earn her a PhD in 1942. [One demonstration hit the front page of the \*Daily Mirror\* and she appeared on BBC television in 1937 \(Figure 6\)](#). Following Mary's death in 1959, Winifred Leyshon ensured that her book *Chladni Figures: A Study in Symmetry* was published posthumously. This beautifully illustrated book remains a testimony to an outstanding experimentalist and populariser of science.

### An era closes

Fifty years after Edith Stoney had founded the department at the Royal Free, Winifred Leyshon succeeded Mary Waller at its head. Thousands of women doctors owed their knowledge of physics to these women. Edith had continued her vigorous support of female professional emancipation until her death in 1938. Mary had shown how modern mass media could present women scientists to the general public. Winifred had demonstrated that gender was no barrier to becoming an electronic engineer. The department had outlived two world wars, including evacuation from London in 1940 and, more significantly, the arrival of the first male students in 1947.

Winifred's retirement in 1952 marked the end of the era of female physics leadership at the Royal Free. The hospital physics department and the medical school physics department were joined under the common leadership of Harold Simons, who brought his research interest in alpha particles from Jo Rotblat's department at Bart's. In 1912, Edith Stoney had argued successfully that an academic vacancy, previously held by a woman, should be filled by a woman. Forty years later, such positive discrimination would have been thought irrelevant. ●

● Winifred Leyshon's circuit for adjustable muscle stimulation (J Sci Instrum 1931;8:202)

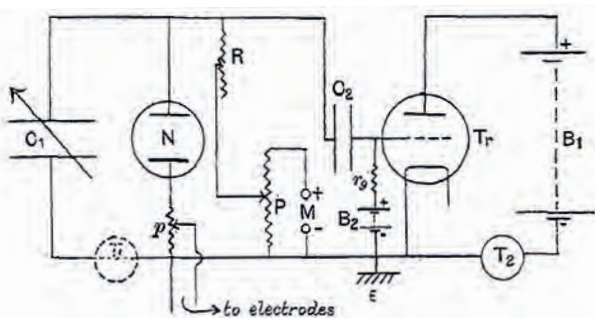



# AUTO-CONTOURING

## for radiotherapy

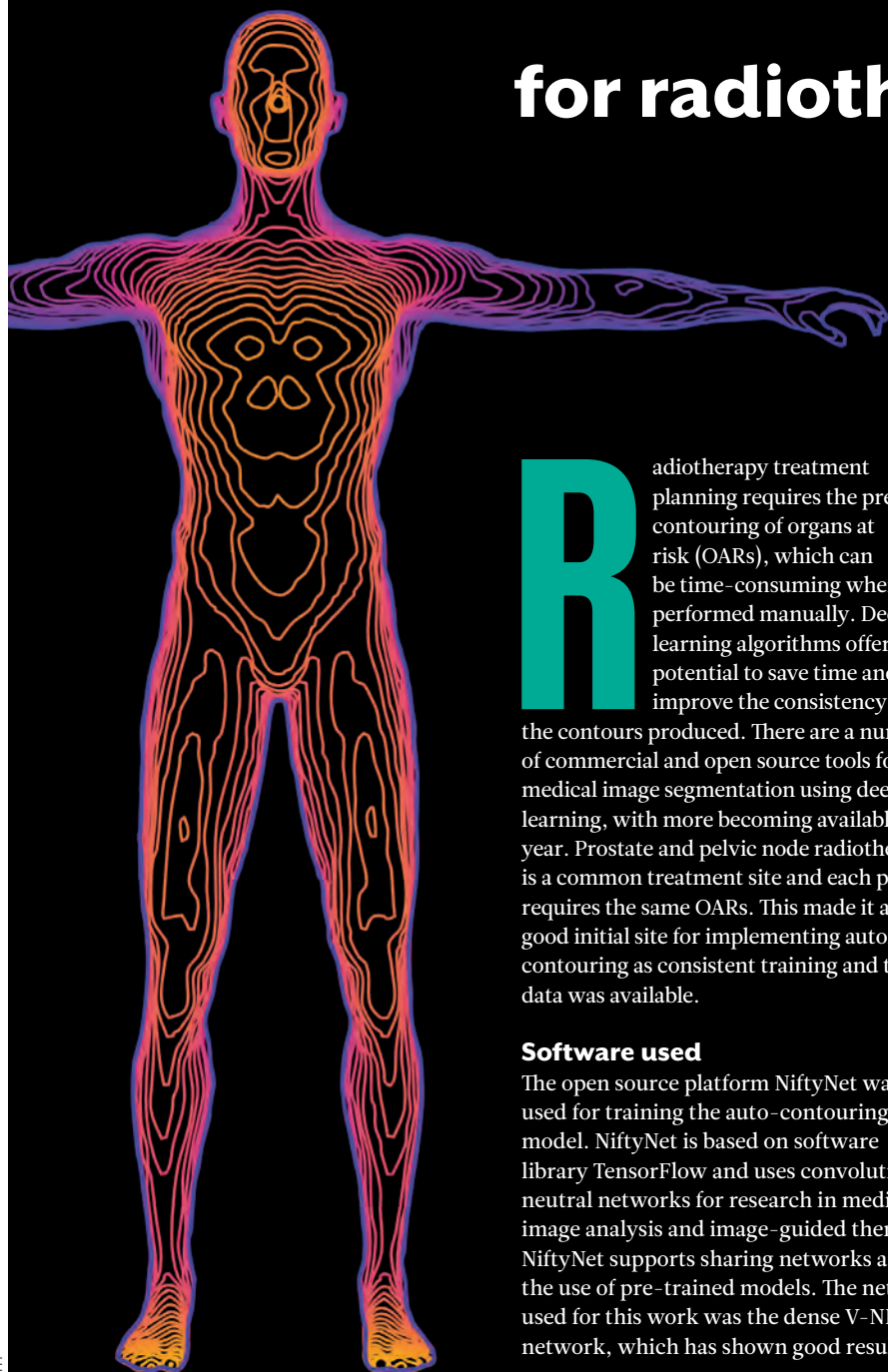

Clinical Scientist **Tim Birtwhistle** and colleagues look at the implementation and evaluation of automatic contouring for prostate and pelvic radiotherapy treatment planning.

**R**adiotherapy treatment planning requires the precise contouring of organs at risk (OARs), which can be time-consuming when performed manually. Deep learning algorithms offer the potential to save time and improve the consistency of the contours produced. There are a number of commercial and open source tools for medical image segmentation using deep learning, with more becoming available each year. Prostate and pelvic node radiotherapy is a common treatment site and each patient requires the same OARs. This made it a good initial site for implementing automatic contouring as consistent training and testing data was available.

### Software used

The open source platform NiftyNet was used for training the auto-contouring model. NiftyNet is based on software library TensorFlow and uses convolutional neural networks for research in medical image analysis and image-guided therapy. NiftyNet supports sharing networks and the use of pre-trained models. The network used for this work was the dense V-NET network, which has shown good results.

The software Plastimatch was used for converting the DICOM CT and structure set files to Nifti format and also for initial cropping of images and some post processing, including smoothing. Locally written BASH and Python scripts checked for new DICOM CT folders being created with a series description including the word 'prostate' and the patient ID having the number of treatment appointments for a prostate and pelvic node treatment. These scripts called the software so that an RT structure set named 'unchecked structs' was automatically created by the time the CT files were imported into the treatment planning system, and could be imported with them.

An Nvidia 24GB Titan RTX graphics card was used for training the models and a separate 8GB card was used for routine contouring as this has lower memory requirements. This means new models can be trained without disrupting the clinical

**Figure 1** Unedited contours produced by auto-contouring

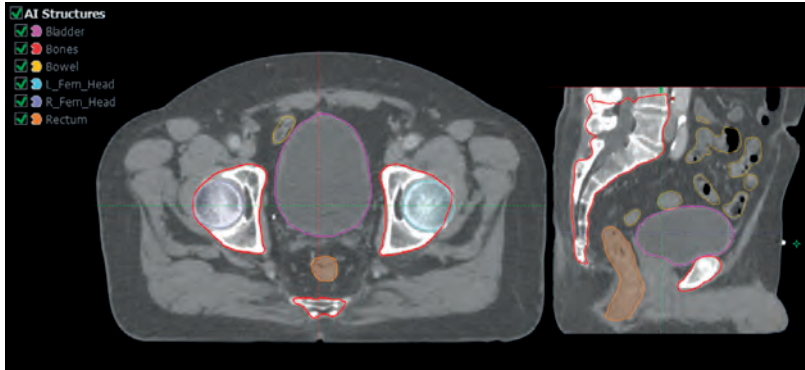

# AI THE FINAL AUTO- CONTOURS ARE AS GOOD AS MANUAL CONTOURS

contouring. Training the model took approximately two days and the script takes around three minutes in total per CT.

## Training and testing

115 CT scans and RT structure sets were split into 91 training cases, 12 validation cases and 12 test cases. The model was trained to contour the bladder, rectum, bowel, left and right femoral heads and bones. The model was also trained to contour the prostate and the nodal target volume but these are not currently being added to the clinical structure set.

The test cases were analysed to determine whether the quality of the contours was consistent between patients and whether the model was likely to introduce a systematic error into the treatment planning process. During initial testing, the auto structure sets were compared to the clinically used structures using DICE and centre of mass measurements. The volume of bowel within a set region was compared to test whether the volume was systematically different. Simple width and length measurements were made on the rectum contours on the central axial slice of the prostate to test whether systematic differences in dose were likely. These tests did not find any evidence of systematic errors being introduced by the auto-contouring. Each structure requires checking slice by slice before being used clinically.

The range of average DICE scores for the OARs using the 12 test patients was 0.86 – 0.97: bladder (0.97), right femoral head (0.94), left femoral head (0.94), bones (0.92), rectum (0.88), and bowel (0.86).

**Figure 2** Contouring time (moving average of last 10 patients)

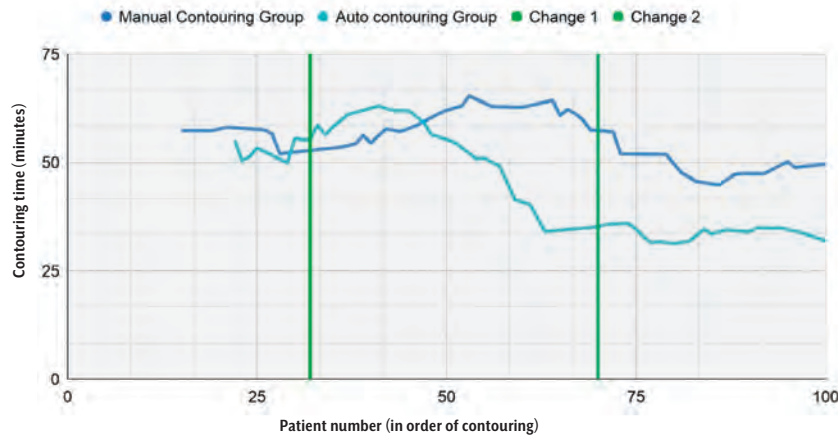

**Figure 3** Consultant feedback score

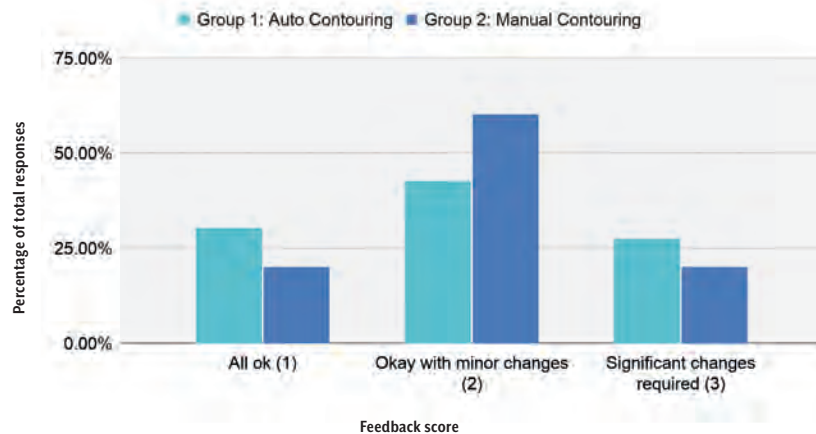

The OARs appeared to be close to clinical quality but most required some editing by a human operator to be full clinical quality. The OARs for all 12 test-patients were carefully reviewed by an independent physicist and a number of examples were presented to a multidisciplinary group including dosimetrists, physicists and consultant oncologists. The quality of the OARs seemed to be good enough that checking and editing the structures would still save time compared with manually contouring. A trial was set up to test the time saving as well as the quality of the final contours and whether the overall process worked well.

### Trial set-up

The previous workflow for prostate/pelvis patients was that OARs were contoured by dosimetrists and then checked by an oncologist and edited if required.

A total of 99 patients were randomised to one of two groups: Group 1 (53 patients) were automatically contoured using the AI script and then checked and edited by an experienced dosimetrist; Group 2 (46 patients) had contours drawn manually by experienced dosimetrists. The time taken for the dosimetrist to complete the contouring was measured using a stopwatch. The contours were checked by an oncologist and then again by a physicist as part of the routine plan-checking process. The oncologist recorded feedback for both groups and rated the contours 'all OK', 'OK with minor changes' and 'significant changes required'. These were assigned scores of 1 to 3, where 1 = 'all OK'.

## REGULATORY COMPLIANCE

Using in-house and open source software in the way described in the article would be classed as a medical device under the EU Regulations for medical devices (MDR2020). These regulations have not been implemented in the UK post-Brexit so the UK Medical Devices Regulations 2002 currently apply which do not require registration for devices not placed on the market. Our approach to deep learning based automatic contouring is essentially one of zero-trust in the software, even if it usually performs well. The contours are checked on each slice by the same person who would have drawn them manually, and that person takes responsibility for the final checked, edited and renamed contours. Robust change management processes within the local quality system were followed.

bowel guide contour included in the initial structure set. This was to reflect the fact that the model was less accurate in the low dose region, due to variable superior limit of contours in training data, but that changes to the bowel contour in this region had a negligible effect on the plan and reported dose. The bowel structure was thought to be the most time-consuming to edit, so avoiding editing outside the bowel guide structure saved further time without negatively affecting the plan. This guide structure was given by an expansion of the predicted target volumes, which was found to include the most important high dose regions (45Gy+ for the 74Gy in 37 fractions treatment). The expansion used for the guide structure was the prostate and seminal vesicles clinical target volume + 6cm combined with the nodal clinical target volume + 2.7cm. The model predicted target volumes but these were discarded except for this use.

### Changes made during trial period

Initially the checking and editing of the auto-contoured structures took a similar amount of time as contouring from scratch. Some dosimetrists were making multiple small edits on each slice, negating some of the potential time saving. The editing process was refined to avoid unnecessary small changes where possible. This followed a discussion between staff groups, and a review of dose comparisons between the automatically generated and edited structures. This is recorded as change 1 on figure 1.

The second change was to only correct the auto-contoured bowel structure within a

### Results

Including all data, mean time for the auto-contouring group: 45 ± 18 minutes, manual contouring group: 55 ± 15 minutes (±1 S.D.). Time saved overall with auto-contouring was 10 minutes per patient, a statistically significant amount (t-test p=0.002). The graph shows that initially the auto-contouring was not saving time and even taking longer than manual contouring.

After change 1: mean time for the auto-contouring group: 39 ± 14 minutes, manual contouring group: 55 ± 15 minutes.

After change 2: mean time for the auto-contouring group: 32 ± 9 minutes, manual contouring group: 49 ± 15 minutes.

The feedback showed that contours from both groups were often edited by the oncologist, but the average feedback score was the same for both groups (2.0 = OK with minor changes). Common regions where changes were made included the rectum/bowel junction and the shape of the femoral heads. Changes in contouring technique have been discussed so consistency can be improved in the future.

After an initial learning curve, the use of an automatic contouring script can save significant time compared to manual contouring. Checking and editing is still required but the final contours are as good as manual contours for the purpose of prostate and pelvic node radiotherapy planning.

### Future uses

The auto-contouring has recently been expanded to include prostate-only treatments as well as prostate/pelvis. This uses the same contouring model but a different protocol for how to check and edit the structures. The regions where auto-contouring may be investigated next are other pelvic sites such as rectum or anus. The NiftyNet software is no longer being developed so moving to another platform may offer advantages in the future. ●

*Tim Birtwhistle is a Clinical Scientist working in Radiotherapy Physics at Weston Park Cancer Centre, Sheffield Teaching Hospitals NHS Foundation Trust. His co-authors are Paul Roxby, Stephen Riley and Stephen Tozer-Loft. They would like to thank the dosimetrists, oncologists and physicists who took part in the trial.*

**T**he headline news is extremely good. The UK's involvement in Horizon Europe – the European Union's key funding programme for research and innovation – has been almost fully protected. We can lead projects, influence funding priorities and contribute to evaluation in the same way that member states can, and we will have the same intellectual property rights as member states. We can compete for funding on equivalent terms to those of member states for all of the important Horizon Europe programmes. The UK will not have voting rights but the speakers were relaxed about this because decisions are normally taken by consensus. All the speakers agreed that this was a very good outcome for UK science. They urged us to make every effort to tell partners in the UK and the EU that the UK is participating fully in Horizon Europe, so as to regain the UK's reputation as a valuable research partner.

#### Concerns

There are some remaining concerns, such as the UK's withdrawal from the Erasmus programme, which funded bilateral visits for staff and students between European universities. This cost the UK around €600m but only brought €250m in direct return (there is a long discussion to be had, of course, about the intangible benefits of Erasmus). The UK is launching a replacement called the Turing Scheme, which will be global and aimed at disadvantaged students, but will only fund UK students to travel overseas. They will seek funding from other governments to fund overseas students to study here.

Possibly the most significant concern expressed during the meeting was over where the funding for the UK's association with Horizon Europe will come from. The UK will pay up to £2bn per year for access to Horizon Europe (opening up a €95bn funding stream over seven years). Last month, the Government made an additional £250m available. This, with reallocation of unallocated budgets, covers most of the £1bn cost for this year. It is

not yet clear how the UK's increasing contribution from £1bn to £2bn over the lifetime of Horizon Europe will be funded.

We also need to make sure the UK is seen internationally as an attractive and welcoming destination for researchers. The cost of a visa to work in the UK is about six times that of other leading scientific nations, which is a deterrent to scientists coming to the UK, as is the tone the Government's messaging on immigration. The panel felt the Government recognises the importance of mobility for senior scientists, but PhD students, early career scientists, technicians and so on may be

overlooked. The challenge is to develop bilateral, reciprocal commitments to mobility, such as the global talent visa.

#### Other impacts

It is anticipated that UK funding bodies will re-examine their international programmes both in response to the agreement and to the Government's recent decision to reduce overseas development funding, which impacts on the Global Challenges Research Fund.

Other issues that might affect IPEM members include data protection. We have a six-month period where data can flow between UK and EU as before, but then

# WHAT DOES THE UK-EU DEAL MEAN FOR SCIENCE?

The Parliamentary and Scientific Committee held a virtual meeting to discuss the implications for science of the UK-EU deal. IPEM Vice President Academic **Professor Adam Gibson** and Vice President External **Dr Richard Axell** attended and share their thoughts on what was said.

we need to negotiate a data adequacy agreement which could limit data transfer. Clinical data wasn't mentioned specifically, but clearly that would be a particular concern. Professional qualifications won't be recognised in the EU by default; for example, the Engineering Council will need to apply for CEng to be recognised in the EU. This may deter an EU employer from selecting a UK candidate due to the extra paperwork and fees required to individually ratify professional qualifications prior to an agreement being put in place. There is no agreement yet on the movement of

IMAGE: ISTOCK

scientific material (including equipment, data, code and biological samples) across borders, which at the moment is treated as any other commodity.

### Engage

Finally, and importantly, there is a clause in the agreement by which the UK's contribution to Horizon Europe can be increased (or decreased) depending on the amount of funding that UK receives. The panel made the case

strongly and unanimously that the best thing that researchers can do is engage with European partners and apply for Horizon Europe funding with enthusiasm so as to maximise the return to the UK. There has

been an understandable dip in funding in the last few years but we should aim to get back to being as full and active a partner as we were before Brexit. This will maximise funding for UK science and convince our European partners that the UK remains a strong, valuable and leading research collaborator. ●

### MEETING SPEAKERS

This was a joint meeting with the Royal Society and was chaired by Stephen Metcalfe MP with four guest speakers: Re Hobley (Department for Business, Energy and Industrial Strategy), Sir Richard Catlow FRS (Royal Society), Martin Smith (Wellcome Trust), and Anne-May Janssen (Universities UK).



#### FAST FACTS

## HORIZON EUROPE

**£2BN**  
PER YEAR

The UK will pay up to £2bn per year for access to Horizon Europe

**€95BN**  
FUNDING STREAM

This will open up a €95bn funding stream over seven years

**2.4%**  
OF GDP

This could help the UK meet its aim of 2.4% of GDP to be spent on research and development by 2027

# CYBERTRON AND THE PHANTOM



## Dr Ejay Nsugbe and Dr Oluwarotimi Williams Samuel look into intelligent cybernetics for self-learning of phantom motion intent from neuromuscular and brainwave bio-signals.

**T**he human hand has 21 degrees of freedom and is undoubtedly pivotal to everyday living and the accomplishment of a variety of tasks. The loss of a limb not only affects overall functionality and quality of life, but also breaks the closed-loop nature of the brain-motor neurons (efferent pathway) and nerves (afferent pathway). Statistics from the UK and Italy show that above elbow amputations – also known as transhumeral amputees – account for the largest cohort of upper-limb amputees missing a significant portion of their upper limb.

Primarily speaking, there are three main kinds of upper-limb prosthesis: the non-functional; the body powered, which is worn like a harness; and the bionic prosthesis, which represents the most advanced form of prosthesis and is addressed in this article. [An overview image of a bionic prosthesis limb can be seen in Figure 1.](#)

The bionic prosthesis works with a control system, whose chief role is to apply an actuation prompt to the motors and actuators in the bionic limb to complete a desired limb motion, given a decoded physiological signal. As written by Nsugbe et al in “Gesture recognition for transhumeral prosthesis control using EMG and NIR”, the pattern recognition-based control scheme is the favoured control method for the bionic prosthesis due to the intuitive control feel which it offers to its users.

Upon receipt of a bio-potential physiological signal, which encodes the motion intent of an amputee, the pattern recognition controller employs an artificial intelligence (AI) classification model, which decodes and correlates the intent signal to a number of pre-trained gesture motions. The favoured classification architecture used in pattern recognition control schemes is the supervised learning framework, where an optimisation sequence is run to find the best model configuration for the identification of labelled training samples from input data. The downside of this approach is the need for an expert to prepare and label the training samples, in

addition to the constraining of the inclusion of any AI intuition in the process, due to the model simply learning the mapping between input data and output label.

To overcome this limitation, a multi-stage self-learning cybernetic model is proposed, which embeds sub-models within its architecture – including an unsupervised learning model – and can find trends, patterns and clusters in data which correlate to various gesture motion intents in a fully automated fashion. The self-learning cybernetic model comprises a feature extraction stage, dimensionality reduction, unsupervised learning and intent decoding.

This article summarises the work done in the paper entitled “A self-learning control scheme for upper-limb prosthesis control using combined neuromuscular and brain wave signals” and involved a collaboration that also included the Centre for Neural Engineering, Shenzhen Institutes of Advanced Technology, China.

### Pilot study

The data used for the pilot study was from a single amputee who had a simultaneous recording of both electromyography (EMG) 32 channels and electroencephalography (EEG) 64 channels signals. The subject was a transhumeral amputee of 49 years who had a left side amputation, was three years post-surgery due to a traumatic accident, and had a stump length of 20cm. Ethical approval was granted for the study by the Institutional Review Board of Shenzhen Institutes of Advanced Technology, with a unique reference number of SIAT-IRB-150515-H0077.

Two key gesture sets from the data were used for this pilot, namely the hand open (HO) and hand close (HC) gestures, which have been seen to be two of the key gesture sets relevant for a bionic prosthesis.

The EMG signals acquire neuromuscular bio-potentials, which are dependent upon the anatomical properties of the individual, using dipole theory and a mathematical model of an extracellular action potential. While the EEG signals acquired record neuronal activities in the form of electrical signals from the surface of the

Figure 1 Image of a bionic prosthesis limb

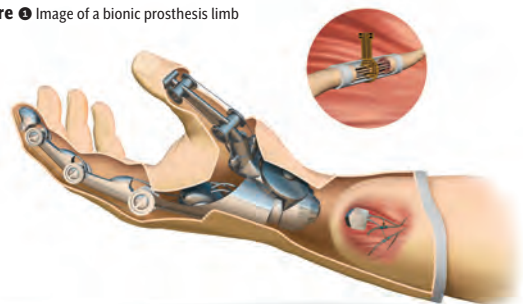

brain, the signals acquired represent neurological bio-potentials from activated regions within the brain.

**Self-learning cybernetic model**

As an initialisation step towards the implementation of the proposed model, the large number of electrode channels were scaled down in order to reduce the computational complexity and allow for a realistic real-time implementation framework. An automated greedy search algorithm by the name of the Sequential Forward Selection (SFS) was used to select optimal electrodes which provided rich bio-electrical information regarding phantom motion intent.

The result of the SFS yield a combined 20 optimal electrodes (10 EMG + 10 EEG), which combined account for about 20% of the total electrode channel. The following was applied to the results:

**(i) Feature extraction and vector fusion**

The following features were extracted from both the EMG and EEG channels followed by a fusion of the feature vectors:

$$MAV = \frac{1}{N} \sum_{n=1}^N |x_n| \quad (1)$$

Where N=number of samples,  $x_n$  is the nth sample of the EMG signal.

$$\text{Waveform Length (WL)} = \sum_{n=2}^N |x_n - x_{n-1}| \quad (2)$$

$$\text{Zero Crossing (ZC)} = \sum_{n=1}^N \text{sgn}(-x_n x_{n+1}) \quad \text{sgn}(x) = \begin{cases} 1, & x > 0 \\ 0, & \text{otherwise} \end{cases} \quad (3)$$

$$\text{Number of slope sign changes (SSC)} = \sum_{n=2}^N \mathcal{A}[(x_n - x_{n-1}) \cdot (x_n - x_{n+1})] \quad \text{sgn}(x) = \begin{cases} 1, & x > 0 \\ 0, & \text{otherwise} \end{cases} \quad (4)$$

**(ii) Dimensionality reduction**

In this stage, the acquired feature vector was reduced in order to remove redundancies which increase computation time. To achieve this, the Principal Component Analysis (PCA) was used. The PCA is a linear dimensionality reduction tool used to compress and project an input vector whilst preserving its structure and minimising loss of information.

**(iii) Unsupervised learning and intent decoding**

The resulting principal components from the PCA step were then projected into a PCA-space ,from which cluster groupings were formed that correlate to the various motion intents, thus actuating a distinct hand gesture in a prosthesis limb. In this step, two unsupervised learning approaches were contrasted as follows;

K-Means: an unsupervised learning method that iteratively separates data groups into K clusters with a centroid mean and Euclidean distance cost function.

Gaussian Mixture Model (GMM): the GMM works with a probabilistic cluster sorting framework and its clustering objective can be parametrised as comprising a mixture proportion, mean and co-variance, and a multi-dimensional model of the GMM framework. Similar to the K-Means, the GMM also employs an expectation-maximisation learning framework for parameter estimation.

**Results**

A model testing method known as Hold-Out was used to assess the effectiveness of the proposed method where the accuracy is expressed as a percentage. [Table 1 shows the results of the Hold-Out exercise for the K-Means and GMM with difference sensor configurations.](#)

The results in Table 1 provide evidence that the cybernetic self-learning framework possesses an automated AI capable of learning from the trend in data, and thus is appropriate for phantom motion intent decoding. From a sensing perspective, the performance of the EMG-only is greater than the EEG-only for both classification methods. In terms of classifier performance, the GMM is seen to be superior to the K-Means. This is thought to be due to the K-Means assumption that cluster separations are spherical, whereas the GMM considers sample co-variance due to the cluster assignment process, which enhances its overall clustering capabilities at the cost of greater computational requirements.

To conclude, a cybernetic self-learning prosthesis controller that comprises multiple stages and can decode phantom motion intents from an acquired EMG and EEG signal has been proposed. This utilises a SFS pre-processing stage first, followed by feature extraction, dimensionality reduction and an unsupervised learning/intent decoding stage. This framework adds a layer of autonomy to the bionic limb and cuts out time associated with human intervention in the supervised learning prosthesis control method. Further work will now seek to validate this framework. ●

*Dr Ejay Nsugbe, Nsugbe Research Labs (NRL) UK, and Dr Oluwarotimi Williams Samuel, Shenzhen Institutes of Advanced Technology, China.*

**|| THIS ADDS A LAYER OF AUTONOMY TO THE BIONIC LIMB**

**Table 1** Results of the model test using a Hold-Out test dataset

	GMM-EMG only	K-Means-EMG only	GMM-EEG only	K-Means-EEG only	GMM-EMG-EEG	K-Means-EMG-EEG
<b>Test-Accuracy</b>	100%	80%	90%	60%	100%	80%



# Data curation and bias

**Clinical Scientist Rollo Moore** looks at balancing user and vendor responsibilities in statistical learnt strategy systems.

**M**edical physics experts (MPE) and equipment are linked in regulation 15 in Ionising Radiation (Medical Exposure) Regulations (IR(ME)R), via the employer's responsibility for quality assurance to any system that "directly controls or influences" (radiation) dose delivered. Those staff competent to discharge these responsibilities exercise due diligence personally as MPEs, and in teams with operators and practitioners. For the radiotherapy team, preparing an optimal treatment plan and delivery is the core activity.

To focus on the radiotherapy physical process, recall radiotherapy treatment planning processes (and associated uncertainties) as described in International Atomic Energy Agency Report 31 Accuracy Requirements and Uncertainties in Radiotherapy symbolised "links in the RT chain" via a flow chart with a single loop in the beam arrangement optimisation cycle. Preceding that loop, "anatomical model: target volume/normal tissue delineation" remains the single step at which the parameters are defined that largely determine the optimal dose distribution and carries a significant amount of the uncertainty. Standardisation within BS 70000 provides a useful framework here, to locate and traverse expertise within

the core activity of plan optimal delivery, which continues to evolve in complexity but maintains a good safety record while improving patient outcomes for several major cancer problems.

## **Quality control**

When MPEs assess equipment performance constancy, quality control is predicated on a 'no-fault design' model. Combinations of causes lead to degradation of equipment performance, with potential large and sudden consequences. Dramatic degradation is unlikely compared with performance drift and our regular quality control monitoring timescale. This is to say that our equipment 'usually works adequately'. In the situation of equipment containing an evolving system, the problem of validation of this evolution opens the problem of drift. To regain hard ground,



‘trustworthiness’ is invoked with notions of reliability and failure mode. In summary, for continual learning strategies, we have to be aware of the temporal bias of ‘now proved’ i.e. that the system is currently ‘proven’, and replace that bias with the system ‘has not yet failed’.

AI as Software as a Medical Device (SaMD) uses statistical techniques of high dimensionality which may be difficult to ‘explain’, but its success in predicting and extrapolating from a given ‘training set’ is established. Artificial intelligence (AI), machine learning (ML) and deep learning (DL) share the methodology of a trained network separated from a training dataset. The training dataset is ‘input’ as a collection of corresponding data and answers and are corresponding images and segmentation labels (for example), or time-series data and change points. The trained network is then used to produce new classifications (responses) on presentation of “suitable” input responses.

Evidence that learnt strategy systems (as adjunct to human expertise) can increase trust, reliability and plausibility of results (compared to human expertise) is available from intercomparison-based approaches to validation in ‘Turing test’ arrangements (human-human, human-computer, computer-computer). Some system comparisons have been published by van Dijk et al 2020 and Oktay et al 2020. Within these reports, recall that the combination of an algorithm and its dataset are used to extrapolate (classify or generate) a suitable response on presentation of a new stimulus.

Evidence provided in target and organ-at-risk delineation studies puts validation requirements for learnt strategy systems in clinical context. Historical and recent work has indicated plausible links between variation in segmentation and outcome: Gywnne et al 2014 (Radiotherapy Trials Quality Assurance) demonstrates human expert variation; Bernstein et al, 2021 derived a useful approach to segmentation including clinical uncertainty; while Jenkins et al, 2021 found an unexpected result associating detriment with overestimated target segmentation. All the work cited represents the importance of (segmentation) uncertainty estimation appropriate to the imaging modality of clinical choice.

## **EVIDENCE THAT LEARNT STRATEGY SYSTEMS CAN INCREASE TRUST, RELIABILITY AND PLAUSIBILITY OF RESULTS IS AVAILABLE**

Looking at change in response to updates is the usual basis of appropriate requirements for the acceptance, commissioning and quality assurance, which the MPE team and the Failure Modes and Effects Analysis (FMEA) task clarifies. The strategy taken by MPE for technology in treatment planning system (TPS) acceptance and commissioning (dose calculation for patient anatomies and geometry) has stood the test of time. Notable failures have strengthened the MPE community approach after the identification of errors, in that they have become “likely errors”, with an appropriate test strategy documented and disseminated. In other words, we learn from these mistakes. Specially trained MPE teams, within clinical teams, should specify the requirements for the introduction or evolution of learnt strategy equipment.

### **Validation and compliance**

A helpful recent advice notice from IPEM March 2021 on production of software in a medical context mentions: “data that tell a computer how to work” are regulated; training datasets are within this description, as “equipment” within the context of IR(ME)R. The duty of care for the MPE in the delivery team is more challenged in dynamic therapy applications than in the static auto-

contouring setting. However, both static and dynamic processes rely on a training set as input in addition to the (trained) network. Examining details in release notes given to users and consideration of the provenance and inherent scope, bias and limitations of training sets are key to MPE risk evaluation. Release notes could include training dataset preparation and associated metadata (prepared under suitable standards). Further, should a national comparator for dataset classes and test cases be available, MPE would have a reference to aid acceptance decisions – an ambitious expansion of the concept behind (national)

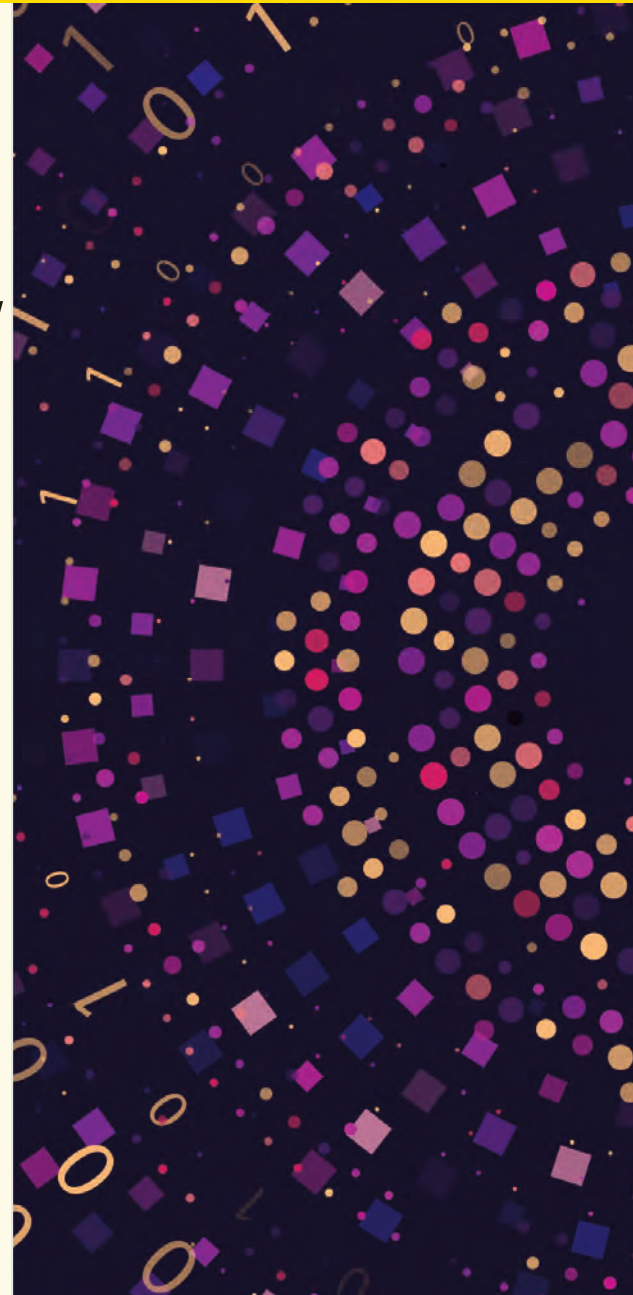



## SUMMARY

- IR(ME)R MPE duties of care extend to dataset/system ensemble, which vendors should identify via universal device identifier (UDI) and market with appropriate approvals and surveillance.
- Increased training and awareness of pros and cons of learnt strategy systems in IPEM and associated radiation therapy professional groups is key as these systems move from horizon into clinic. Strengths of human awareness to monitor responses is key to local safety risk mitigation.
- IPEM is among key stakeholders to co-ordinate the generation and dissemination of appropriate (synthesised or permissible real) test datasets with metadata descriptions to collate fail cases and reconciliations.
- On the technology horizon, the time window for human intervention in optimisation is narrowing – to ‘catch’ the patient anatomical information at ever closer state to delivery for personalisation of treatment.
- Working cooperatively to formulate useful test strategies for evolving learnt strategy systems is an ideal way to meet vendor and user responsibilities, and the UK has institutions and framework to meet the challenges in advance of the wave.

reference levels in radiological physics.

Useful validation strategies mix routine (standard) scenarios and probe the limits for failure cases, testing standard and extreme cases. Evolutionary updates through a pre-agreed acceptance plan could include test-pass and test-fail cases. Some failures and reconciliations are desired and useful. Due diligence supports safe and timely patient care – testing every delivery is implausible, but testing a relevant subset is critical.

The various regulations for medical devices and software have different approaches to compliance and approval to permit vendors to market products

to users. The requirements of inspection and notifications, classifications and surveillance arrangements are well summarised

in documents from Medicines and Healthcare products Regulatory Agency (MHRA), British Standards Institution (BSI) and the Association for the Advancement of Medical Instrumentation (AAMI) in the UK and EU. Post-market surveillance was described in a white paper from BSI as a “comprehensive system to gather experience from the use of devices”. This shall “allow update of technical documentation including the risk/benefit determination, clinical evaluation and performance evaluation” and “allow cooperation on vigilance and market surveillance”. In IR(ME)R, tasks of

reviewing performance monitoring and reporting are duties of the MPE.

## Conclusion

The UK has strong and wide approvals, accreditation, standards and testing infrastructure and in-house medical device guidance (from IPEM). IR(ME)R states the duties of MPE around “equipment” and one interpretation is that learnt strategy equipment is within this classification. The SaMD update frequency in current radiotherapy practice is less likely to benefit from continual learning but more from piecemeal updates – quality control of this process needs to judge when risks might outweigh benefits. Current local testing with peer group and reporting via IPEM and professional network (conferences and publications) is likely to be adequate while systems remain relatively static. Training in IPEM around learnt strategy systems would benefit from increased priority. Involvement of vendor via post-market surveillance and unique device identification systems for dataset updates would be guided by IPEM reports to plan effort, resource required and opportunities opened. This risk balance and mitigation task that we face constrains our goal: patient focused care and safety from incomplete knowledge of the equipment.

The MPE is best placed to engage with post-market surveillance and lead the formal risk and priority assignment with the local team for an acceptance and commissioning program. This should draw on each group’s expertise and requirements: MPE, Head of Department, clinician, radiographer and bioengineers in an FMEA type group to locally identify risk for this new class of software. Regular QC should continue to use human expertise or secondary independent learnt strategy equipment. Training and education on statistical learnt strategy systems should be enhanced within IPEM training membership as it is in the Royal College of Radiologists syllabus. ●

*Rollo Moore is a Clinical Scientist at the Royal Marsden Hospital. He kindly acknowledges critical review and input from Edwin Aird, Gerry Lowe, Dualta McQuaid and Ladislav Urban. References have been supplied and can be requested from [rob.dabrowski@redactive.co.uk](mailto:rob.dabrowski@redactive.co.uk)*

# Artificial intelligence in radiology

**Philip Cosgriff and Matthew Memmott describe the main potential areas of application of artificial intelligence in radiology and nuclear medicine.**

**W**ork already done on AI in mainstream radiology can either be applied directly to nuclear medicine (NM) or readily adapted. Because NM is primarily a diagnostic imaging modality, the most obvious area of application is in scan reporting/clinical decision support, but other areas of application include data correction and data processing. Nuclear medicine has always been associated with a high degree of image data processing, especially for dynamic, gated, single-photon emission computed tomography (SPECT) and positron emission tomography (PET) studies, but AI-enabled automation promises to take this to a new level of accuracy and sophistication.

Professional bodies are currently debating the many ethical questions and dilemmas around the use of AI in medical practice. A recent (US/European) multi-society statement on the ethics of AI in radiology made various recommendations, including the development of detailed codes of ethics and practice. The use of advanced AI technology in diagnostic medicine carries huge potential benefits

as well as some significant risks. Correct implementation will require a carefully planned and coordinated effort on behalf of, among others, commercial developers, NHSX (see below), nominated departmental representatives, local IT staff and most importantly, consultant radiologists, NM consultants, senior clinical scientists and technologists.

## Machine and deep learning

The basic ideas around AI are not new. AI was founded as an academic subject in the 1950s with the aim of creating algorithms and technologies that allowed computers to mimic certain aspects of intelligent human behaviour, and, thereby, to perform repetitive tasks in a more efficient and reproducible manner. Machine learning (ML) describes a family of techniques for achieving this; enabling computers to 'learn' specific features/attributes and create generalisable models, ranging from simple regression techniques to more advanced clustering/classification algorithms and neural networks.

More recently, the concept of deep learning (DL) has gained widespread publicity, but is simply a tool that facilitates ML. The rapid increase in computational

power in recent years has led to the practical usability of DL techniques. The concept of DL is an evolution of the neural network and describes a dense multi-layer network with hundreds of thousands of individual connections, crudely analogous to synapses in the brain. Each connection has a weight and bias that can be iteratively optimised, allowing highly non-linear/extremely complex functions to be 'learned'. In the field of imaging, the recent advances have come from analysis of convolutional neural networks, where image features and spatial relationships can be encoded as network inputs.

## The national framework

NHSX is a joint unit combining teams from the Department of Health and Social Care and



IMAGES/ISTOCK



# AI POTENTIALLY, AI SYSTEMS CAN PERFORM BETTER THAN HUMANS AT DETECTING TINY ABNORMALITIES

NHS England, whose stated aim is to “drive forward the digital transformation of health and social care”. Its origins can be traced back to a report (*Accelerating AI in Health and Care*) published by the Academic Health Science Networks (AHSN) in late 2018. NHSX is still in its infancy but plans to take forward some of the policies and programmes previously developed by NHS England. Within its AI Lab, designed to “accelerate the safe adoption of AI in health care”, NHSX has an AI Imaging programme. This is seen as having an important supporting role in the development and implementation of AI imaging systems within the NHS. It aims to establish an AI imaging platform, designed to “make it easier for clinical staff to find and utilise the latest AI technology safely and effectively”. The platform will comprise a networked computer system that, once

the needs assessment exercise has been completed, NHSX intends to procure by commercial tender. It will probably follow the work already done on the National COVID-19 chest-imaging database (NCCID), whereby a large number of CT, MR and chest X-ray images (obtained from collaborating UK hospitals) were made available for validation purposes. Details are still sketchy, but it is clear that commercial AI imaging systems to be sold within the NHS will need to conform to regulations specified by NHSX.

## Recent developments in mainstream radiology

There was initial opposition to government plans for the introduction of AI in primary and secondary care, with much scepticism from the Royal College of General Practitioners and the Royal College of Physicians. Critical editorials appeared in the *British Medical Journal* and *The Lancet*. At around the same time (2017), in response to House of Lords Select Committee Enquiry on AI in Healthcare, the Royal College of Radiologists (RCR) produced a paper calling for proper clinical governance and regulation of AI systems in radiology.

There have already been several examples of a culture clash between fast-moving high-tech computer companies and the more conservative medical establishment. Some AI software producers unwisely set about trying to demonstrate that their products

were as good or better than human doctors, while some eminent computer science academics added fuel to the fire by making unrealistic claims about the possible impact of AI in medical practice; a classic example being a statement made at an AI conference in 2016 by the so-called ‘godfather of AI’ Geoffrey Hinton that “people should stop training radiologists now” and “it’s completely obvious that within five years DL will do better than radiologists” – a somewhat ridiculous claim that demonstrated a lack of understanding

**Figure 1** Images showing the generation of a synthetic attenuation correction map from the primary and scatter images

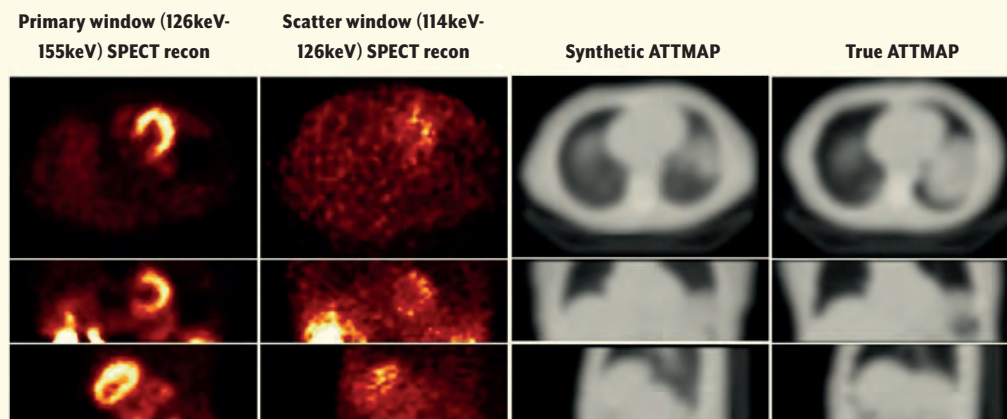

[Originally published in EJNMMI. Shi, L.; Onofrey, JA; Liu, H et al. Deep learning-based attenuation map generation for myocardial perfusion SPECT. *Eur J Nucl Med Mol Imaging* 2020; 47:2383-2395. © Springer Nature].

of how radiological diagnosis works.

Thankfully, things have moved on over the last few years and radiologists world-wide now seem much more positive about the use of AI technology. Pioneering radiologists now speak of a future “augmented by artificial intelligence”, which sounds much more acceptable. The increasing interest in AI can be gauged from the number of recent publications. In 2008, there were barely 100 peer-reviewed papers world-wide. In 2017 there were nearly 650, mostly (66%) on CT and MR applications, but also general radiography, mammography, ultrasound, PET and SPECT. Potentially, at least, AI systems can perform better than the human observer at detecting tiny/subtle abnormalities (especially when the observer is fatigued), but detection is, of course, just

the first step in the process of producing a clinical report. As the process of reporting NM images is essentially the same as that for CT, MR etc, the benefits for NM should be similar. The nature of NM/PET images is fundamentally different to those obtained from CT and MR, but the principle behind the use of AI in a reporting context is the same: namely, to automatically, rapidly, and accurately detect potentially significant abnormalities that can be highlighted (by the computer) for further evaluation by a suitably qualified and experienced reporter.

### Current initiatives in NM

Medical physicists working in radiology or NM are used to developing mathematical models and ‘software phantoms’ for research purposes, so will be naturally receptive

to AI concepts. Work is currently being done in university hospitals around the world, as well as large commercial medical equipment companies. Any software development carried out in-house by NHS clinical scientists for routine clinical use should adhere to best practice guidelines produced by IPEM. Here we report on a couple of examples to illustrate the possibilities.

### Data corrections

Nuclear medicine imaging constitutes a high-noise representation of a series of physical processes from photon emission to detection. While these processes are known and well understood, their interactions are highly complex and it is not possible to completely recreate the true activity distribution from the sparse data we record. However, where we expect a relationship to be present (such as between scattered photons, primary photons



and the local attenuation) DL can be used to unravel the highly complex and non-linear relationships at a voxel level. For example, by reinforcing the learning against a ground truth, such as the corresponding attenuation map, a mathematical model can learn to predict the attenuation map for any given pair of scatter and emission window images, see Figure 2. This map can then be fed into a traditional iterative reconstruction algorithm to generate attenuation-corrected images without the need to expose the patient to the additional radiation of a CT scan.

### Data analysis

The above illustrates how we might use AI to generate a synthetic realisation of one domain from another (e.g. an attenuation map from photon emission data). A somewhat simpler application of DL is segmentation, in which a network is trained using a set of manually drawn regions-of-interest (ROI). Given enough clinically heterogeneous data to learn from, the trained model can then be used to automatically delineate the required anatomic regions on any similar input image. This is potentially of huge benefit in NM, where a significant amount of clinical scientist/senior technologist time is taken up performing manually driven image processing procedures. As well as obvious efficiency gains, inter-observer variability

**Figure 2** Myocardial images demonstrating correct identification of LAD disease (85% stenosis) using deep learning in a case where traditional methods (combined total perfusion deficit, cTPD) had failed

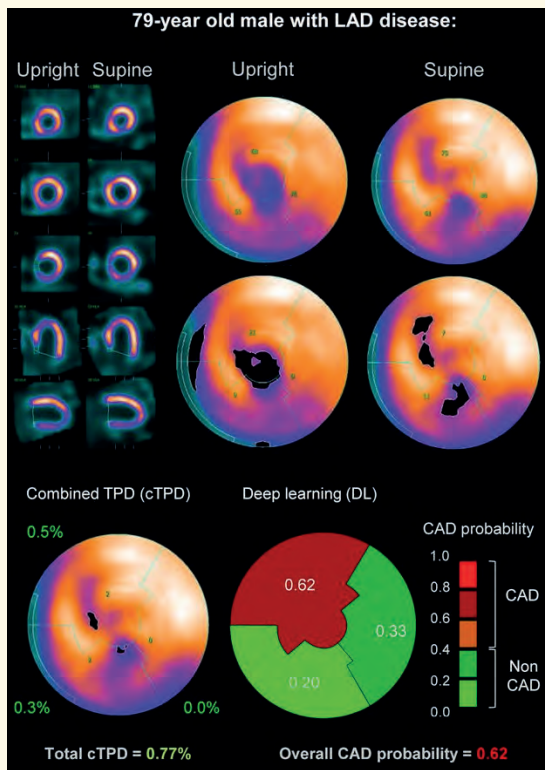

[Originally published in JNM. Betancur, J; Hu, L; Comandeur, F et al. Deep learning analysis of upright-supine high-efficiency SPECT myocardial perfusion imaging for prediction of obstructive coronary artery disease: A multi-center study. *J Nuc Med* 2019; 60:664-670 © SNMMI].



## MEASURES FOR IMPLEMENTATION

- Full support of the Trust's Chief Executive and Directorate management.
- Appointment of a Project Manager and the establishment of a fully documented Project Plan.
- Adherence to NHSX guidance on procurement, patient engagement and data protection.
- Formal and extensive training for all staff who will use the new system(s) in routine clinical practice.
- Development of an evaluation strategy (i.e. how will the success of the project be measured?).

on direct patient care, as well as other high-level tasks such as clinical audit, research, and teaching. Patient waiting times (for reports) should be improved, as should other departmental quality standards. Clinical scientists working in NM will oversee increased automation in the areas of data correction and data processing, leading to improvements in departmental efficiency, reproducibility and diagnostic accuracy.

Clinical validation of AI-based systems is the key to acceptance

in image processing would be virtually eliminated. However, the model would need to be as general as possible to ensure that any unusual clinical presentations (e.g. ectopic organs) be correctly identified and appropriately handled. Despite this general requirement, there will sometimes be a need to train particular AI models locally (i.e. using local patient data); a task that may only be feasible in the largest and best-resourced departments.

### Clinical reporting

A basic attribute of any DL or generalisable AI technique is the size and heterogeneity of the data from which it learns. In a clinical setting this requires access to thousands of cases, containing image data, clinical history, clinical report and follow-up. For example, in the US, the REFINE SPECT data registry has been created to help developers make AI tools for assisted clinical reporting, identification of obstructive coronary artery disease and prediction of early coronary revascularisation outcomes.

### Applicability of medical device regulation

Standalone medical software that meets the definition of a 'medical device' (i.e. software as a medical device, SaMD) is regulated under both European and US regulations. Within the EU, the type of AI/

ML software envisaged for routine clinical use in radiology and NM would be subject to the same regulatory requirements as hardware medical devices. The regulatory requirements for in-house developed SaMD are not as strict, but the project management and quality assurance requirements are still onerous (see IPEM guidelines for in-house manufacturing and use).

The regulatory position of the UK has been complicated by Brexit, while the COVID-19 pandemic caused a 12-month delay to the planned June 2020 implementation of the new EU medical devices regulations (MDR 17). As a result, they had not taken full effect in member states when the UK left the EU on 31 January 2021. Although the provisions of MDR17 will not be directly transposed into UK law, it is thought that most of the key aspects will be adopted when UK government produces its Medicines and Medical Devices Bill. Until such legislation is implemented, medical device manufacture in the UK will continue to be regulated under the UK Medical Devices Regulations 2002.

### Summary and conclusions

It is still early days for AI in diagnostic imaging but the consequences are likely to be far reaching. Radiologists will, over time, exchange the more laborious aspects of the reporting process for more time spent

by radiologists and referring clinicians, and AI suppliers must therefore ensure that appropriate experts are involved throughout all stages of product development. In summary, the potential benefits of AI for both patients and staff would appear to hugely outweigh the risks. There are certainly potential pitfalls, but adherence to well established project management techniques and national guidelines should help to avoid most of them. In this regard some measures will be important for "full blown" AI implementations (see box).

It seems fitting to end with a quote by Dr Jason Moore, Director of the Institute for Biomedical Informatics at the University of Pennsylvania: "Learning from the past, if we can just meter our excitement and allow for this technology to be developed at a reasonable pace, with realistic goals, it's possible that we could reach some of the heights we'd always hoped. We need to realise, once again, that nothing in medicine ever comes easy, and all of the intelligence in the world, artificial or not, won't change that." ◻

*Philip Cosgriff is a retired Consultant Clinical Scientist. Matthew Memmott is a Consultant Clinical Scientist at the Nuclear Medicine Centre, Manchester University NHS Foundation Trust.*

# Should you trust a computer to tell you if you have cancer?

How does a healthcare professional separate marketing hype from modernising clinical practice in the ever-changing world of artificial intelligence and machine learning? Clinical Scientist **Ioannis Argyridis** investigates.

**B**reast cancer screening uses X-ray mammography to diagnose cancer in the early stages from full field digital mammography (FFDM) images. After the images are taken, there are many detection and classification methods, ranging from completely manual and labour intensive (a single radiologist meticulously reviews every part of the image), double reading (two radiologists review the images

independently, the preferred method in the UK/EU), to completely automated using CAD (computer aided detection/diagnosis) software.

CAD as currently utilised, mainly in the US due to insurance policies supporting its use, does not improve diagnostic accuracy or patient outcomes but increases recall rates and false positives.

Advancements in artificial intelligence (AI) brought us a new generation of CAD utilising machine learning (ML). ML uses sets of classified images as training data to build a model for the localisation, feature extraction and classification of lesions into

benign, malignant or normal. There are many methods to accomplish the above and there are many researchers, as well as companies claiming high sensitivity and specificity of their models in diagnosing cancer, with the majority utilising deep convolutional neural networks (DCNNs). However, a higher sensitivity does not paint the whole picture. The exceptionally high accuracy, along with promises to revamp the field of CAD, have been met with healthy scepticism and concern due to the lack of theoretical analysis of identifiability and convergence, validity or explainability of the neural network



IMAGES: SCIENCE PHOTO LIBRARY





## THE REGULATIONS CURRENTLY AVAILABLE ARE NOT ADDRESSING THIS NEW TYPE OF PRODUCT

models. Let us not forget, the big promises of AI have been largely exaggerated in the past. Despite many claims that the NHS should stop training radiologists, they are still in high demand.

It has become apparent that public health bodies and professionals need to find a way to verify bold marketing claims, rigorously validate the classification process, and check the trustworthiness and usability of the software to verify whether it is fit for purpose.

The most suitable healthcare professional to perform this evaluation is none other than the medical physicist who has a solid

background in science, statistics and computers but is based at the hospital already commissioning, testing, and evaluating medical devices in oncology and radiology.

Unfortunately, the regulations and guidelines currently available are not adequately addressing this new type of product, which is a SaMD (Software as a Medical Device). While we wait for new regulations and guidelines to come into effect, here I present a set of metrics - summarised in Table 1 - that you should ask before buying any ML products and could be used in the evaluation of CAD in mammography, possibly the area with the most ML products available. Here are the criteria:

**1** How big is the dataset used to train the algorithm? What percentage of benign lesions were there? What kind of imaging equipment was used? Now compare that to your case. Ideally you need at least 100,000 images.

**2** What is the accuracy on equivocal cases? Check that the algorithm works just as well on difficult cases. Ideally sensitivity and specificity should remain at above 95%.

**3** What is the target population (specifically age/ethnicity/pre-existing conditions)? Can you use the model in your local area?

**4** What kind of pre-processing is required on the images? Do you have to manually segment and feed images to the algorithm? Ideally pre-processing is done automatically in the background.

**5** Can the algorithm explain what features were abnormal in that area? There are many features such as morphological, physiological, etc. What are they and how are they calculated? Do they agree with the radiologist?

**6** If you feed the same (or even different) dataset, can you get consistently high sensitivity, specificity or AUROC (Area Under the Receiver Operating Characteristic)? Ideally the above metrics stay the same with less than 1% variation.

**7** How was the model optimised? Does the model converge on a solution, or was training simply halted at an arbitrary point? Ideally, the model converged to a solution as is the case with SVM (support vector machines).

**8** What is the uncertainty on your classification? The uncertainty should be clearly shown for each lesion.

**9** What validation method was used during training? Ideally the validation was done with a completely different dataset never seen before by the model.

**10** Do artefacts affect the classification? What happens if the patient moves or some pixels in the detector are dead? Ideally the classification stays the same.

**11** What happens when we feed the same image but rotate it or magnify it first? Ideally the classification stays the same.

**12** Is your model explainable? In the case of neural networks, the model should have fewer than 10 convolutional layers.

**13** Can it produce meaningful actionable reports just like a radiologist? Ideally, it should agree with the reporting Royal College of Radiology guidelines.

**14** Can the algorithm point to the suspicious area? Ideally it should highlight the area with the lesion. Does that area (shown by ROI or heat map) agree with the radiologist?

**15** Does the classifier allow for various stages of classification such as normal, benign, benign

no-call-back, malignant and inconclusive? Ideally, it should allow for all stages.

**16** How easy and speedy is the classification? Ideally, it should be done within seconds, in the background and with full PACS integration.

**17** Does the classifier allow human intervention? What happens when it fails? Ideally, there should be risk assessments and contingency plans in case of system failure.

**18** Were the patients informed of the change in methods? Ideally, patients should be allowed to choose if they want their images reported by a ML model or a radiologist.

**19** Is the CAD classed as a SaMD with CE marking and FDA approval? Ideally, it should be at least grade IIa according to the current medical device regulation MDR.

**20** Can the manufacturer supply a Use Specification document, which includes indicated use, intended use, foreseeable misuse, and relevant IEC 62366-2:2016 conformance? Ideally, the manufacturer can provide all of the above.

## ML SAMD MAY HELP ALLEVIATE PRESSURE BY AUTOMATING SOME OF THE MORE MUNDANE TASKS

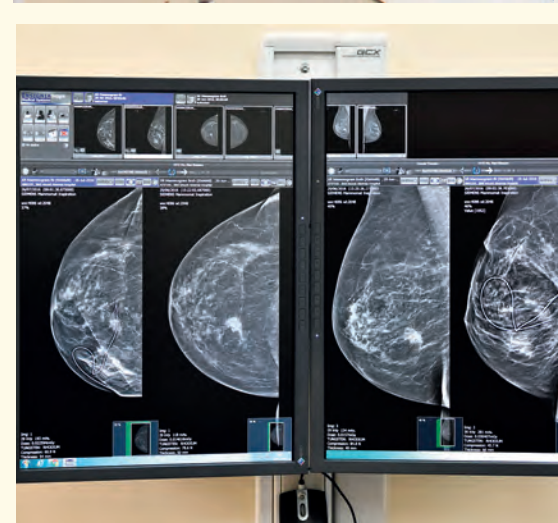



**Table 1** Evaluation criteria for ML CAD mammography SaMD

#	Category	Criterion
1	Dataset	Quality/sample size
2		Difficulty of cases
3		Population characteristics
4		Pre-processing
5	Model	Feature extraction appropriateness
6		Reproduction of performance metrics like AUROC
7		Error rate minimisation method
8		Uncertainty on metrics used
9		Quality of validation methods
10		Impact of artefacts
11		Impact of adversarial attacks
12		Model complexity/explainability
13	Implementation	Meaningful/actionable reports
14		Saliency/heat maps used for output
15		Output BIRADS compatible
16		Ease and speed of classification and adoption
17		Role of human intervention/supervision
18		Patient consent/role
19	Regulatory	CE marking as a medical device and risk grade
20		Provide Use Specification document
21		Provide prospective randomised clinical trials or investigations
22		Post-market surveillance plan, post-market clinical follow-up plan
23		Compliance with the regulations/acts/policies for ICT, MDR
24	Ethical	Written compliance with Ethics guidelines
25		Disclosure of funding sources/investors

I have taken this list of criteria and used it to evaluate freely available mammography classifiers found on GitHub. From my own analysis the results are not promising, with most software having issues with reproducibility. This does not mean that the work in AI and ML is impossible; on the contrary, it shows that much work is needed before we can safely deploy such software in a clinical setting. I would like to make it clear that I am not against the use of AI or ML in healthcare, I simply ask for higher standards in ML SaMD.

We are all aware of the immense pressure the healthcare system is under, even more during the COVID-19 pandemic. ML SaMD may help alleviate that pressure by automating some of the more

mundane tasks. However, any change in procedures, such as how mammography screening images are reported, should not just be a cost saving move, but genuinely improve patient outcomes.

This list of criteria is simply a rough guideline regarding good manufacturing standards for mammography CAD that implements ML, and can easily be adapted to other diagnostic uses of ML in healthcare. ◉

*Ioannis Argyridis is a Clinical Scientist and Medical Physicist working in PET CT and Nuclear Medicine at Cromwell Hospital, London.*

**21** Can the manufacturer prove the software improves patient outcomes? Ideally, we would like a prospective randomised controlled clinical trial that proves efficacy for intended use and superior performance to radiologists.

**22** Is support and maintenance provided by the manufacturer and under what conditions? Ideally, the manufacturer can provide a comprehensive post-market surveillance/clinical follow-up plan.

**23** Can the manufacturer show compliance with upcoming legislation like the new MDR? Can they comply with ISO 62304, ISO 14971, ISO 27001? Ideally, yes to all.

**24** Does the manufacturer comply with EU's Ethics guidelines for trustworthy AI and ISO 14155:2011: Good Clinical Practice? Again, this is needed.

**25** Can the manufacturer disclose its data sources, funding sources, investors, and collaborators? There should be minimal risk of bias.

**Dr Laurence Vass and Professor Phil Blower**  
look at the latest developments and future  
possibilities in molecular imaging for research.

# Molecular imaging research

## Exploiting opportunities and innovations

**M**olecular imaging and therapy with radionuclides are powerful tools for research, clinical diagnosis and cancer treatment. Furthermore, radionuclide molecular imaging has increasing relevance as a modality which can contribute to the goal of precision medicine. In principle, it is possible to label any metabolic substrate, receptor or drug with a radionuclide; hence the potential to explore pathophysiological processes with radiotracers is vast. However, this potential is currently unmet due to the poor availability of these tracers nationwide. This is in part due to the complexity of radiolabelling processes and the requirement for specialist facilities and infrastructure. However, advancements in radiochemistry have been developing rapidly in tandem with a multidisciplinary approach that includes biologists, physicists, mathematicians, engineers and clinicians across many specialisms.

## The outlook

At the present time, there is cause for optimism that molecular imaging has a bright medium-term future since, although there are no major focused funding calls targeted to this field, there are several concurrent major responsive-mode grants operating across the UK, involving extensive inter-institutional collaboration and networking. Ongoing, funded UK-wide networks include the UK-PET Network (dedicated to improving access to positron emission tomography (PET) facilities and radiopharmaceuticals) and the Cancer Research UK National Cancer Imaging Translational Accelerator programme (which aims to overcome barriers to clinical translation of all imaging modalities, including radionuclide imaging in cancer).

In addition, there are several concurrent major focussed research programmes funded by the Engineering and Physical Sciences Research Council (EPSRC): (i) Next Generation Molecular Imaging and Therapy with Radionuclides (MITHRAS) programme, an £8m collaboration spanning King's College London (KCL), Imperial College London and University of Southampton and numerous industry partners, which is focussed largely on novel radiochemistry to support radiotracer development; (ii) similar in scale to MITHRAS, chemical biology tools for investigating the chemistry of cellular REDOX stress (redOx-KCL) is a joint Oxford University/KCL project aimed at imaging REDOX metabolic processes, which has a significant radionuclide imaging arm based at KCL; (iii) again similar in scale, the Probing Multiscale Complex Multiphase Flows with Positrons for Engineering and Biomedical Applications (PEPT), which spans Birmingham University, KCL and Edinburgh University, aims to apply PET imaging to understanding fluid dynamics in engineering and medical contexts.

## Collaboration

These programmes show the importance of the wider network of institutions that have developed with collaborative funding. The aim of the KCL-based MITHRAS programme is to produce novel chemistry that is fast, simple and less costly to facilitate more accessible tracers and reduce the dependency on complex infrastructure, to overcome limitations in patient access to PET tracers and support new clinical and scientific uses of emerging technologies (see figure 1). An integral part of MITHRAS and other programmes is to utilise, alongside radiochemistry developments, advancements in physics technology and data analysis to help drive the clinical translation of novel tracers. Below we outline some of the key developments in molecular imaging that we aim to

# AI-DRIVEN IMAGES WILL ALLOW SHORTER ACQUISITIONS OR LOWER DOSES

utilise in programmes undertaken at KCL and within our collaborative networks.

## Total Body PET

Notwithstanding the significant improvements in detector technology, including the promise of digital detectors, perhaps one of the most fundamental shifts in our approach will be the adoption of Total Body PET (TBP). Extending the axial field of view to cover the entire body length results in an unprecedented 40-fold improvement in sensitivity over conventional whole-body PET scanners. The initial observations made on the newly available TBP scanners have demonstrated promising improvements in image quality (see figure 2). This opens up a series of new possibilities for PET imaging, which could exploit multidisciplinary developments emerging from programmes such as MITHRAS. For example, as more cell-based therapies enter clinical trials, there is a growing need for advanced cell tracking (e.g. using PET) to determine the fate and survival of administered cells; the increased sensitivity of TBP will allow lower administered radioactivity, therefore minimising any potential perturbations to cell behaviour due to radiation dose and further extend the imaging time to unprecedented levels (up to 10 half-lives post-injection of  $^{89}\text{Zr}$  have been reported).

TBP also opens the possibility to apply mathematical modelling of tracer kinetics to all organs and tissues without sacrificing fast tracer dynamics. An obvious application would be obtaining the whole-body pharmacokinetics of new drugs, when combined with the increased sensitivity (hence potential for lower radiation dose) may accelerate the translation of new therapies. Better understanding of the origin of the PET

**Figure 1** Overview of the MITHRAS programme. The multidisciplinary programme spans a number of interrelated themes, each with its own aims, which will empower and utilise emerging technological innovations (e.g. total body PET and AI).

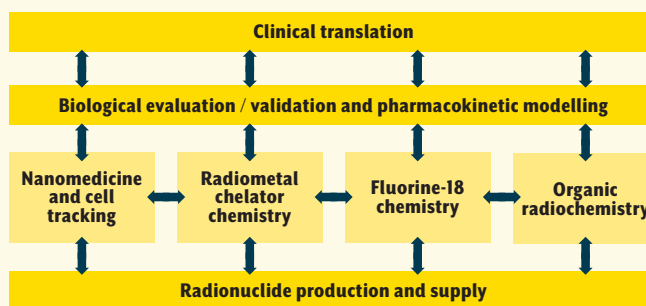



**Figure 2** Total Body PET. (a) Photograph of uEXPLORER total body PET scanner mock-up installed at University of California Davis Medical Center. (b) Images from the uEXPLORER total body PET scanner of early, mid and late scans demonstrating the image quality achievable throughout covering the entire body. SUV images shown in inverse gray scale with maximum set to 9. This research was originally published in, and reproduced with the permission of, JNM. (a) S.R. Cherry et al. Total-Body PET: Maximizing Sensitivity to Create New Opportunities for Clinical Research and Patient Care. *J Nucl Med.* 2018;59(1):3-12. © SNMMI and (b) X. Zhang et al. Total-Body Dynamic Reconstruction and Parametric Imaging on the uEXPLORER. *J Nucl Med.* 2020;61(2):285-291. © SNMMI

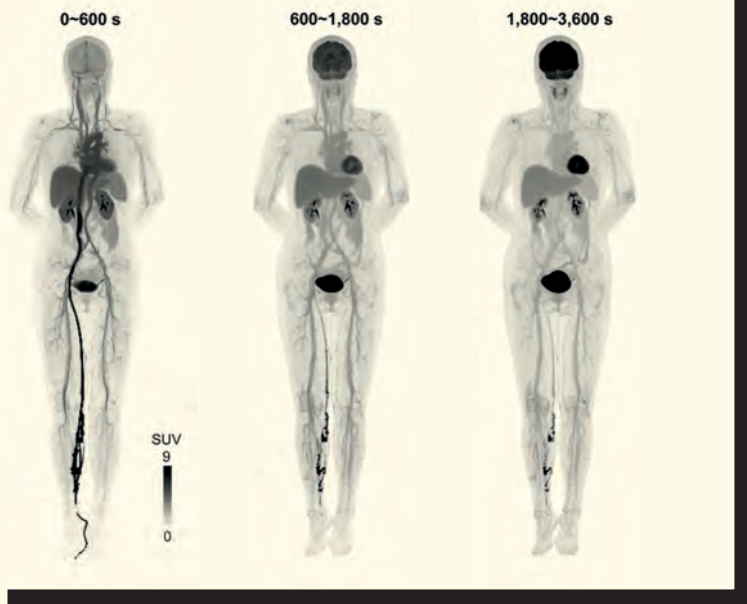

signal for novel radiotracers is paramount in programmes such as MITHRAS, especially with improved clinical translation as a goal, and the higher temporal resolution achieved on total body PET will benefit increasingly complex kinetic models. These kinetic models will allow additional information to be extracted from scans that can be related to biologically and physiologically relevant processes. Total body parametric images have recently been demonstrated, including using advanced reconstruction techniques such as direct parameter estimation. These are only a few of the applications of TBP

pertinent to our own research – doubtless other investigators will exploit other opportunities. For example, leveraging the low dose capabilities will extend the uses of PET to paediatric and perinatal applications, and furthermore will allow the exploration of biology and physiology of healthy individuals using tracers that can address questions existing tools cannot. In addition, lowering doses while maintaining image quality improves the prospect of using multiple tracers in the same subject to allow targeting of different aspects of underlying pathophysiology.

### Artificial intelligence

In tandem with improvements in instrumentation has come the maturation of artificial intelligence (AI), which has brought about a paradigm shift in many research fields, including medical imaging, where it continues to reshape the way we approach many problems. For example, AI-driven image reconstruction will produce improvements in image quality and allow shorter acquisitions or lower doses. Another exemplar area is the delineation of tissues of interest; when performed manually, such tasks are time-consuming and prone to inter-observer differences. Aided by the abundance of existing data, these tasks are well suited to AI algorithms which are capable of providing full automation.

We may also be able to exploit AI to help better utilise the potential list of novel PET tracers made more accessible by programmes like MITHRAS. As briefly noted earlier, so-called ‘multiplexed’ imaging – near simultaneous imaging of multiple PET tracers in the same patient – would allow information to be gathered on multiple biologic or physiologic processes within the same target tissue. Such a technique has been hampered in PET due to the near identical photon energies of all PET tracers and the complexity of producing multiple tracers at once. Among other benefits, removing the need for temporally separated PET scans would eliminate the confounding effect of changes in the tissue and errors introduced by image registration. This will enable improved understanding of the relationship between PET images and underlying molecular processes potentially leading to greater clinical insight, complementary to the previously mentioned benefits of kinetic modelling in TBP. It is our hope that programmes such as MITHRAS will empower these technological innovations, allowing increased understanding of the pathophysiology of disease, and will better enable us to address clinical needs. ●

*Dr Laurence Vass is a Post-Doctoral Research Fellow in Molecular Imaging Science and Professor Phil Blower is Professor of Imaging Chemistry and Head of Department of Imaging Chemistry and Biology. Both are at King’s College London.*

# AI in nuclear medicine

Principal Clinical Scientist **Sofia Michopoulou** looks at some of the different uses for artificial intelligence in nuclear medicine.

**T**he Topol Review, published in 2019, identified artificial intelligence (AI) as a key technology to transform the delivery of healthcare in the NHS. Back in 2018, when IPEM was asked to contribute evidence in preparation for the review, the clinical applications of AI in nuclear medicine were mainly in the field of radiomics. Since then, a multitude of studies have used AI methods for image reconstruction, denoising, segmentation and even radionuclide dosimetry. Some of these applications are finding their way into clinical practice.

## AI for image reconstruction

End-to-end approaches such as DeepPET use neural networks to reconstruct positron emission tomography (PET) images directly from sinogram data and can accelerate reconstruction speed by 100 times. Deep learning methods that leverage anatomic information (such as magnetic resonance imaging or computerised tomography) can improve the signal-noise ratio in low count data and enable ultra-low dose PET with up to 200-fold dose reduction (Figure 1).

In single-photon emission computed tomography (SPECT) imaging, a deep convolutional U-structured network was recently used to create synthetic intermediate projections from <sup>177</sup>Lu-Dotatate SPECT data. The synthetic projections had good similarity to the projection data, as shown in figure 2. This methodology enables using sparsely acquired projections to produce high quality SPECT reconstructions with a four-fold reduction in scan acquisition time.

## AI for radionuclide dosimetry

Monte Carlo (MC) simulations provide the golden standard in radionuclide dosimetry but are computationally intensive. Due to time constraints, simplified models following the Medical Internal Radiation Dose Committee formalism are routinely used in clinical practice, but have limitations in accounting for different tissue densities and activity distribution heterogeneity within an organ.

Recently, deep neural networks (DNNs) have been trained for predicting the distribution of energy deposition on a voxel by voxel basis. The DNNs can account for patient-specific anatomy, providing dosimetry results with mean relative error <3% compared to MC as shown in figure 3. Radionuclide dosimetry using DNNs can provide absorbed dose calculations at a fraction of the time needed for MC dosimetry and may be the key to bringing high accuracy radionuclide dosimetry into clinical practice.

## Radiomics and diagnosis

Radiomics are machine learning pipelines designed for medical imaging. These pipelines include tissue segmentation, feature extraction and pattern classification algorithms bundled together to provide a diagnostic decision support system. There are numerous applications of radiomics in nuclear medicine and some are finding their way into routine clinical practice.

In the field of segmentation, AI-based methods are now available for lung

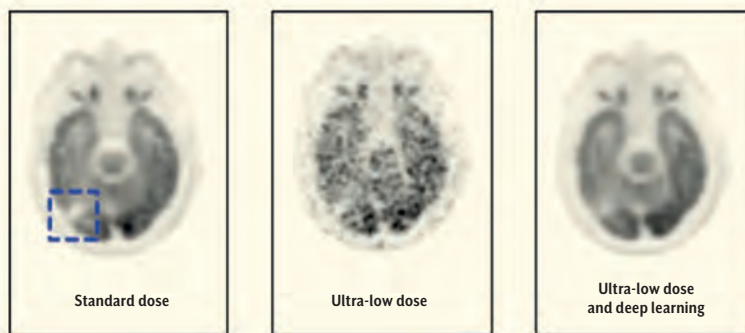

**Figure 1** Brain FDG PET scan reconstruction using conventional and deep learning methods on ultra-low dose data, adapted by Junshen Xu, Enhao Gong, Jiahong Ouyang, John Pauly, and Greg Zaharchuk "Ultra-low-dose <sup>18</sup>F-FDG brain PET/MR denoising using deep learning and multi-contrast information", Proc. SPIE 11313, *Medical Imaging 2020: Image Processing*, 113131P (10 March 2020)

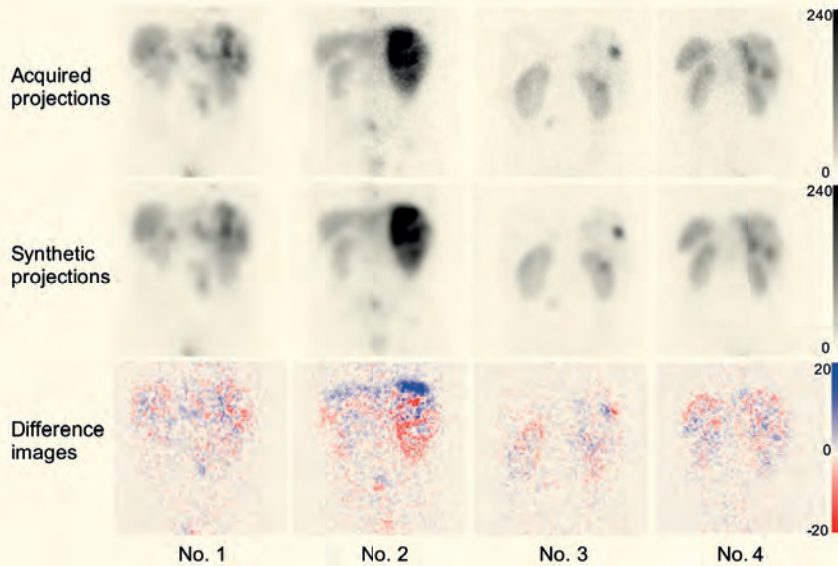

**Figure 2** Comparison of acquired projections with the corresponding synthetic intermediate projections, adapted Ryden T, van Essen M, Marin I, Svensson J, Bernhardt P. Deep learning generation of synthetic intermediate projections improves <sup>177</sup>Lu SPECT images reconstructed with sparsely acquired projections. *Journal of Nuclear Medicine*. 2020 Aug 28; jnumed-120

## AI METHODS COULD TRANSFORM NUCLEAR MEDICINE BY UNLOCKING LOW-DOSE IMAGING

perfusion scans and identify disease patterns, which would help automate diagnosis of these scans. Over the next three years, I will investigate the role of inflammation in dementia progression as part of the BRAIN AI project (Biomarker Research Assessing Inflammation in Neurodegeneration using AI) supported by an NIHR Integrated Clinical Academic Lectureship. Inflammation is considered a driving force accelerating dementia progression. This project will combine neuroimaging data with biomarkers derived from blood and cerebrospinal fluid samples aiming to identify patterns of disease progression relating to neuro and peripheral inflammation. The AI tool that will be developed as part of this will provide imaging and neurology experts with the patient's current neurodegeneration status and their estimated risk of dementia progression, to enable early and objective diagnosis.

### Limitations of AI

The limitations of AI should be addressed to ensure its effective and safe use in clinical practice. AI methods have an insatiable appetite for large datasets that are challenging to compile in a single clinical

segmentation from ventilation perfusion SPECT/CT scans. These enable automated lobar extraction of quantification of lung function, which may be helpful in predicting post-operative outcomes in patients undergoing lung volume reduction surgery.

In PET/CT, AI methods based on convolutional neural networks have been used to segment the prostate from <sup>18</sup>F-Choline scans and enable automated quantification of organ volume and total lesion uptake. The quantitative features extracted using this fully automated pipeline significantly associate with the patient's overall survival.

Another application of convolutional neural networks – and specifically the LeNeT architecture – is in the classification of DATSCAN images for the diagnosis of Parkinson's disease. As shown in Figure 3, isosurfaces of the striata were first calculated and thresholded to create feature maps. This helped

reduce dimensionality of the input to the convolutional neural network. The method showed 95% accuracy in the diagnosis of Parkinson's disease.

### My project on AI in dementia

AI is growing rapidly and in the field of mental health and neuroimaging it is expected to transform patient care in the next three to 10 years. I recently started developing a tool for dementia diagnosis, as part of an NHS Digital Topol fellowship and a SHAPE award from National Institute for Health Research (NIHR) Applied Research Collaboration Wessex. In the first instance, I am using AI methods to analyse brain

**Figure 3** Dose distributions of a lung lesion drawn on axial views comparing dose maps calculated using DNNs against MC simulations, adapted by Akhavanallaf A, Shiri I, Arabi H, Zaidi H. Whole-body voxel-based internal dosimetry using deep learning. *European Journal of Nuclear Medicine and Molecular Imaging*. 2020 Sep 1:1-3.

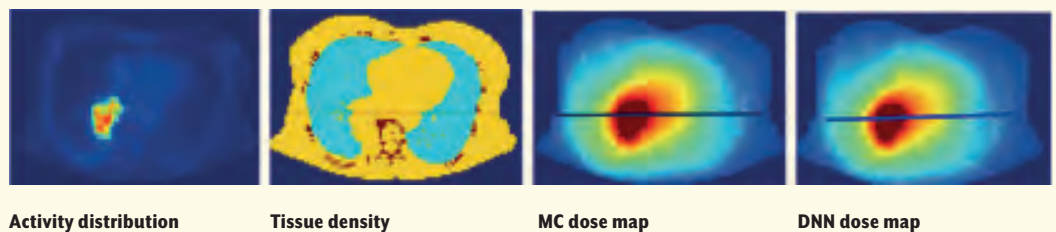



**Figure 4** Isosurfaces extracted from DATSCAN images demonstrate loss of symmetry between left and right striata in Parkinson's Disease. Martinez-Ibañez M, Ortiz A, Munilla J, Salas-Gonzalez D, Górriz JM, Ramirez J. Isosurface Modelling of DatSCAN Images for Parkinson Disease Diagnosis. In *International Work-Conference on the Interplay Between Natural and Artificial Computation*. 2019 Jun : 360-68. Springer, Cham.

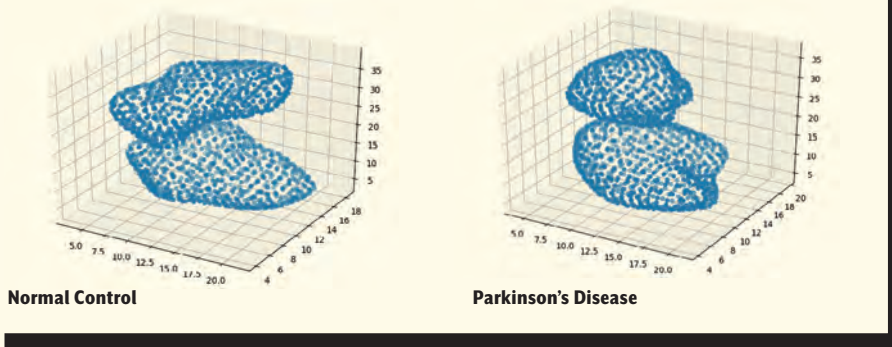

the lack of interpretability of certain AI models. Advanced AI techniques are black box approaches where the mechanism of action is not well understood. In the case of image recognition tasks, methods such as activation maps can support interpretability of AI models by providing visual insights to the inner working of neural networks.

**Conclusion**

Nuclear medicine has been a quantitative modality since its early days. It is now rapidly adopting AI methods across a range of applications. These could transform nuclear medicine by unlocking low-dose imaging, fast and accurate voxel-based dosimetry and earlier more objective diagnosis and prediction of disease progression. ◻

*Sofia Michopoulou is a Principal Clinical Scientist at University Hospital Southampton NHS Foundation Trust and an HEE NHS Digital Topol Fellow.*

setting. Bringing together datasets from multiple institutions are likely to be the key to compiling the large databases needed for training and testing AI-based tools. Stringent standardisation between imaging datasets would be required to support

building robust databases. Data labelling and avoiding bias is another consideration. To reduce bias, databases must be inclusive and representative of the population and pathologies encountered in clinical practice. Another important limitation is

OSL is the exclusive distributor for IBA Dosimetry within the UK & Ireland

**myQA<sup>®</sup> SRS**  
Digital SRS/SBRT Patient QA Solution

The new myQA SRS solution uniquely combines the best of both worlds:

- Unrivalled accuracy & resolution of film QA
- Proven efficiency of digital detector array workflow



Contact OSL to arrange a demo.



**Oncology Systems Ltd**  
+44 (0)1743 462694  
enquiry@osl.uk.com  
**osl.uk.com**

**IPEM INTERNATIONAL SCHOLAR**

# A challenging year in Italy

**Eduardo José Florian Ché** from Guatemala is IPEM’s International Scholar. Here he gives a personal account of his year studying in Trieste.

**O**n 7 January 2020 I arrived in Italy and started my life as a foreign student and an IPEM student. Being in an unfamiliar country, with a different culture and language, is undoubtedly one of the toughest challenges I have faced in my life. That’s before life took an unexpected and drastic turn with the COVID-19 pandemic. But, despite everything, it has been an interesting and wonderful experience that would not have been the same without the support of my university friends.

From the beginning of my journey, I was accompanied by one of my university programme friends. I met Kevin Vega from El Salvador en route to Spain, when my flight made a stop at El Salvador airport. Facing an unfamiliar country with a friend who speaks my language, provides support, and inhibits the fear and the idea of having to face something unfamiliar alone, was very comforting.

**The first lockdown**

A totally new and difficult experience – especially considering that I didn’t understand and knew absolutely nothing of the Italian language – was to find an apartment to rent in Trieste. There were two things that made this experience a little easier. First, was that the apartment search was carried out with two friends from the master’s programme, Oscar from Ecuador, and Kevin. The second thing was that the apartment turned out to belong to one of the professors at the university who spoke English.

Renting an apartment with my friends Kevin and Oscar was one of the best decisions I could have made at the beginning of my arrival in Italy. No one expected to have to live a three-month lockdown due to coronavirus. Without a doubt, living through this with colleagues was the best thing that could have happened to me. My friend Alejandro, who is studying for his PhD in the US

told me that living a solitary lockdown is not at all pleasant.

Thankfully during my lockdown I was able to talk and play some board games with my roommates. There were even times when we would gather in the living room to do exercises, as our physical activity had been reduced to a minimum. Before the lockdown, every Friday we would meet with a group of students to have a friendly football match. Sadly, due to preventive measures, such events were cancelled.

**Easing of restrictions**

At the end of the three-month lockdown, the classes continued online, but interaction with my friends from the master’s programme grew. My group of friends now comprised a wide cultural





## THIS WONDERFUL EXPERIENCE WOULD NOT HAVE BEEN THE SAME WITHOUT MY UNIVERSITY FRIENDS



variety, including – Olga from Belarus, Shirin from Uzbekistan, and Kätlin from Estonia. Being able to exchange information from their lives, their countries and their inspirations made being away from my country and family much easier.

During the summer, about to finish the second term of my theoretical year, and with the decrease of the restrictions, we were able to make a trip through Italy with my colleagues, where we encountered beautiful places and landscapes. Among them were Lake Lecco, Sirmione, Verona, Milano, Varenna, Peghera, Trento and Vicenza. After our trip, we decided Trieste was a good place to spend the summer, as we could go to Barcola and swim in the sea, which I regularly did with my friends Olja and Katlin.

I remember several university professors and colleagues from

Guatemala telling me that the hardest part of being a foreign student was being away from your loved ones, especially during the New Year holidays. It's true – I missed my family during those celebrations, but I was never alone. My group of friends from the

master's programme understood that feeling, each expressed it and felt it in their own way, so we decided to spend these celebrations together.

We had dinners for Christmas and New Year and even made a gift exchange that ended up making the night really quite cheerful.

### Goodbye

I'm about to finish the first year of the master's degree in Italy and yet it seems to me that only a few months have passed. Perhaps it is due to the unexpected stages in which this year was divided for me. The arrival in Italy, a new language and another culture, the challenges of the classes and, above all, the pandemic. But now it's time to say goodbye to my master's group. We will now each to move to the city in Italy where we were assigned to complete our clinical year. We've said goodbye for a moment, but now we know that we are not alone, that Italy is no longer an unknown country for us and that we can better face what we will find in this last year of our clinical training. ●

### IPEM INTERNATIONAL SCHOLAR

The IPEM International Scholar is an initiative to support a student from a low- or middle-income country to attend a master's programme in Medical Physics in Trieste. IPEM offers a range of student and trainee grants and prizes and travel grants, which are open to members. For more information on these, and a range of other IPEM awards, grants and prizes, visit [ipem.ac.uk/aboutipem/prizesandawards.aspx](http://ipem.ac.uk/aboutipem/prizesandawards.aspx)

**OBITUARY**

# John Rowland Mallard

**Professor Peter Sharp OBE, Emeritus Professor of Medical Physics at the University of Aberdeen, pays tribute.**



**J**ohn Mallard passed away peacefully on 25 February at the age of 94. John was one of the most important figures in medical physics of his generation – and it all started with slices of bacon!

He was born in Northampton, where his father ran a grocery shop. John remembered using a bacon slicing machine and stacking up the slices to reform the joint. Why, he thought, could you not produce images of slices of the body to facilitate diagnosis? That is what we know now as tomography.

John took a degree and doctorate in physics at Nottingham. His move from academia into medical physics was, in part, due to his poor hearing. He was told by his adviser at Nottingham that this would be a great disadvantage for him as a lecturer. An advert for a physicist to work in radiotherapy led him to his first

appointment as Assistant Physicist at the Liverpool Radium Institute in 1951. This was where his involvement in imaging started.

John moved to the Hammersmith Hospital in 1953 to set up an NHS radioisotope laboratory. There he built a radioisotope rectilinear scanner, the world's first whole body scanner, and with it he pioneered organ scanning. The Medical Research Council (MRC) cyclotron unit was nearby and while it was being used for trials of neutron therapy, it could also produce radioisotopes. Using a pair of scintillation detectors, John showed how positron emitting isotopes of arsenic could be used to image brain tumours.

After a brief spell at Guy's, he successfully applied for the newly created Chair in Medical Physics at Aberdeen University.

John's vision was broader than just nuclear medicine. He had published a paper in *Nature* in 1964 showing how electron

spin resonance (ESR) could differentiate between normal and malignant tissue. Developing ESR as an imaging tool did not prove feasible at the time but, when Raymond Damadian showed that there was a difference in nuclear magnetic resonance (NMR) signals between tissues, Aberdeen was in a position to explore this.

Not only did they confirm Damadian's findings but, following work done by Paul Lauterbur, they constructed a small NMR imager and produced the first image of a mouse, in March 1974. This demonstrated that the technique could produce images showing body structure but, as it required an hour to produce an image, the mouse had to be killed first – somewhat of a problem if the technique was to be used clinically!

At this point John took a decision that was to have profound consequences for MRI. Rather than continue an incremental approach, building bigger and bigger



John Mallard with one of his experimental body scanners - John and his team at Aberdeen built the first whole-body MRI scanner.

imagers, the Aberdeen group would build one capable of whole-body human images.

With support from the MRC, John's team constructed what was to be the first whole body clinical MR imager. By employing pulse sequences repetitively, they were able to reduce imaging time to about 20 minutes. However, all attempts to produce 3D images were spoiled by organ motion. Finally, the team came up with what was to prove the breakthrough that MRI needed - the spin-warp imaging pulse sequence.

Several weeks of trial imaging on team members ensued and on 26 August 1980 the first patient was imaged. The images showed not only the known tumours but others in the spine. The first announcement of this breakthrough was made at a nuclear medicine conference that John was attending in Heidelberg a few days later.

John realised that if the intellectual property was to be protected then a patent would need to be taken out. Fortunately, a government agency had been set up to develop intellectual property and they prepared the patents. Inevitably the medical device companies tried to break the patent. The ensuing court case ran up costs of £1.5m. We won the case, and John estimated that during its lifetime the patent generated £34m of income.

John went on to build a second imager dedicated to clinical work. In the absence of

## II HIS RADIOISOTOPE RECTILINEAR SCANNER WAS THE WORLD'S FIRST WHOLE BODY SCANNER

other sources of funding he reached an agreement with a Japanese company, Asahi, which in return for funding would get access to the know-how. At the same time, John set up a company to manufacture the imager. However, it was undercapitalised and they sold just three machines. In comparison, Asahi sold 145 machines before selling the technology to Siemens.

John's vision of using ESR was not dead and imaging technology derived from this concept is currently being developed in Aberdeen by Professor David Lurie.

John's interest in the use of radioisotope imaging had also not waned. During the 1970s he built several photon emission tomography imagers, in the process

producing medical tomographic images several years before Godfrey Hounsfield's X-ray CT imager was invented.

In his inaugural lecture in 1965, John talked about the potential of positron emission tomography (PET) imaging. In 1976, following a public appeal, he bought a site for a PET centre. He obtained a second-hand cyclotron and a second-hand PET imager and, with these, set up the second PET centre in the UK.

John maintained his view of the importance of professional activity in medical physics. He set-up an MSc course in Medical Physics in 1968 which is still running.

He was a President of the Institute of Physical Sciences in Medicine (now IPEM), the Biological Engineering Society, and the International Organisation for Medical Physics, and the Founder Vice-President of the European Nuclear Medicine Society. He was also the Founder President of the European Society for Magnetic Resonance in Medicine and Biology and the International Union for Physical and Engineering Sciences in Medicine.

He received many honours and prizes during his career including the OBE, the freedom of the City of Aberdeen and the freedom of his birthplace, Northampton.

One, now retired, NHS Chief Executive who worked with him had this to say: "John Mallard was one of the most difficult characters I have ever had to deal with, but that was more than compensated by his brilliance and utter determination to achieve what he knew could be done. My experience of working with him was a highlight of my career and I am honoured to have known him." Not a bad epitaph! ●

BOOK PITCH

# Modelling the mind



Computational neuroscientist **Grace Lindsay** outlines the ideas behind and the content within her new book.

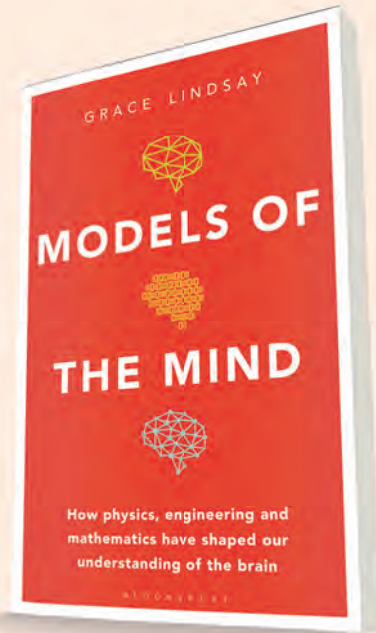

**L**et me tell you about a common experience of mine: I meet someone new at a party or on a plane and they ask what I do. I answer “computational neuroscience” and then – awkward silence. While I’ve been working in the field for 10 years, most of the people I meet outside it have no idea what it is or that it exists – and certainly don’t have anything to say about it. If you also work at the intersection of mathematics and biology, you may have a similar story.

Broadly speaking, computational neuroscience is a field of research that applies concepts from mathematics and physics to understand the brain. The brain is a complicated organ. Made of billions of neurons, each with different features and properties, interacting to produce all of our thoughts and actions, the brain is frequently referred to as ‘the most complex object in the known universe’.

**“ I TELL PEOPLE WHAT I DO AND THEN – AWKWARD SILENCE ”**

Yet, despite this complexity, much of the historical study of the brain has eschewed mathematical models when trying to make sense of it. Physicists and engineers, on the other hand, know how important it is to make their statements precise and quantitative—that is, they know the value of mathematics when trying to understand and control the natural world. Thankfully, neuroscientists are increasingly coming around to this view as well.

I wrote the book *Models of the Mind* to share with a wide audience the many fruitful ways in which quantitative thinking has changed how we view the brain: from modelling single neurons as electrical circuits to comparing the interactions between neurons to those

between particles in a gas; from the influence biological vision has had on artificial vision to using the equations of control theory and reinforcement learning to explain human behaviour. In total, the book documents the wide range of areas of neuroscience touched by mathematics. It not only explains these use cases,

but also covers the history of how psychologists, biologists, computer scientists, physicists, engineers and mathematicians have interacted in unexpected ways. In this way, it reveals an influence from other fields that many practicing neuroscientists may not even be aware of. In addition, an important theme throughout the book is that mathematical models are only meant to be mere approximations—not exact replicas—and that the art of modelling involves finding just the right approximations to use.

I think this book would be of interest to both practising scientists and engineers as well as a broader audience. Personally, I can say that learning about the history of my field has affected how I approach my research. But I also wrote the book in an accessible and engaging way meant to encourage any reader to get excited about the future of the study of the brain. After all, the brain will not be understood through words alone. ●

*Models of the Mind: How Physics, Engineering, and Mathematics Have Shaped Our Understanding of the Brain* (Bloomsbury Sigma) by Grace Lindsay is available at [bloomsbury.com](https://www.bloomsbury.com) and at all good bookshops.

# Can you **write an article** for *Scope*?

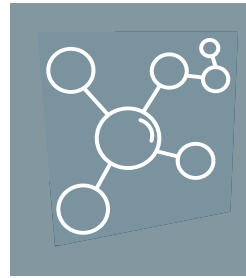
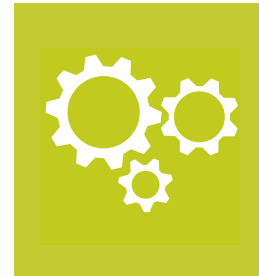

***Scope* is YOUR magazine and we rely on your submissions! If you have an idea for a feature article or a review article then please get in touch. Articles from members on topical themes ensure that *Scope* is current and relevant, whilst review articles provide valuable background material to developments and innovations.**

I am sure you agree that *Scope* is a high-quality publication for IPEM members to read. We seek to make it relevant and important reading material for people working in the field, as well as anyone with an interest in medical physics and clinical & bioengineering. To ensure that *Scope* is filled with interesting, informative and valuable material, we rely entirely on you to submit articles.

*Scope* is published four times a year and includes a varied number of feature articles. This is only possible if you continue to provide us with great material. The readership survey revealed that a number of people were willing to write articles. If you were one of the people who expressed interest in doing so (or even if you weren't!), please give it serious consideration. Perhaps you have an idea that could be turned into a feature article but do not feel you are the right person to write it? Ask a friend! Alternatively, simply let us know about your idea and we will try to take it forward.

**The submission process is simple and articles are normally published in the next issue. It will also count towards your CPD.**

For more information please contact the Editor:  
Rob Dabrowski | 020 7324 2752  
rob.dabrowski@redactive.co.uk

IF UNDELIVERED PLEASE  
RETURN TO:-  
IPEM  
Fairmount House  
230 Tadcaster Road  
York  
YO24 1ES  
UK



# XORAN

## MiniCAT IQ

**High Definition (0.1mm)** images optimised for sinus, ear and skull base

**Specialised** protocols for ENT and Allergy

**View Scans** in under a minute

**Integrate** with EPR and navigation systems

**Streamline** in-office diagnosis and treatment



**Field of View**

Temporal Bone  
16 x 6.5 cm



Sinus  
16 x13 cm



020 8391 4455 | [sales@dpmedicals.com](mailto:sales@dpmedicals.com) | [www.dpmedicals.com](http://www.dpmedicals.com)